

Data Sheet

H1P 115/130

Axial Piston Single Pumps



For more than 40 years, Danfoss has been developing state-of-the-art components and systems for mobile machinery used in off-highway operations around the world.

We have become a preferred supplier by offering the best of what really matters: The hardware inside your vehicle application.

The H1 range is built around an advanced control and available in a wide range of displacements. It is designed for quality and reliability and offers expanded functionality, greater total efficiency, and easy installation.

All H1 control and sensor options are PLUS+1® Compliant. PLUS+1® allows you to rapidly develop and customize electronic machine control. It opens up the future by combining machine controls and diagnostics in an integrated operating network.



Features

Designed for quality and reliability

- One design concept
- Single piece swash plate

Wide range of controls

- Electro-hydraulic controls:
 - Electrical Displacement Control (EDC)
 - Forward-Neutral-Reverse (FNR)
 - Non-Feedback Proportional Electric (NFPE)
- Automotive Control (AC)
- Fan Drive Control (FDC)
- Manual Displacement Control (MDC)
- Hydraulic Displacement Control (HDC)
- Common control across entire family

Greater total efficiency

- Minimized control losses
- Improved charge circuit
- Lower control pressure for less power consumption

Installation and packaging benefits

- Length optimized pump
- Minimum one clean side
- Higher corner HP / package size ratio
- Standardized connector interface

Expanded functionality

- PLUS+1® Compliant control and sensor options
- Integral filtration available with integrated filter bypass sensors and switch

For more information see the H1P 115/130 Axial Piston Single Pumps Technical Information, **BC00000198**.

Comprehensive technical literature is online at www.danfoss.com

Technical Specifications

Parameters		Size 115	Size 130
Displacement cm ³ [in ³]		115.2 [7.03]	130.0 [7.93]
Input speed min ⁻¹ (rpm)	Minimum	500	
	Rated	3200	
	Maximum	3400	
System pressure bar [psi]	Max. working*	450 [6528]	
	Maximum	480 [6960]	
	Min. low loop	10 [145]	
Case pressure bar [psi]	Rated	3.0 [44.0]	
	Maximum	5.0 [73.0]	
Weight (without PTO and filter), kg [lb]		83 [187]	

* Pressures above max. working pressure requires Danfoss approval.

Schematic

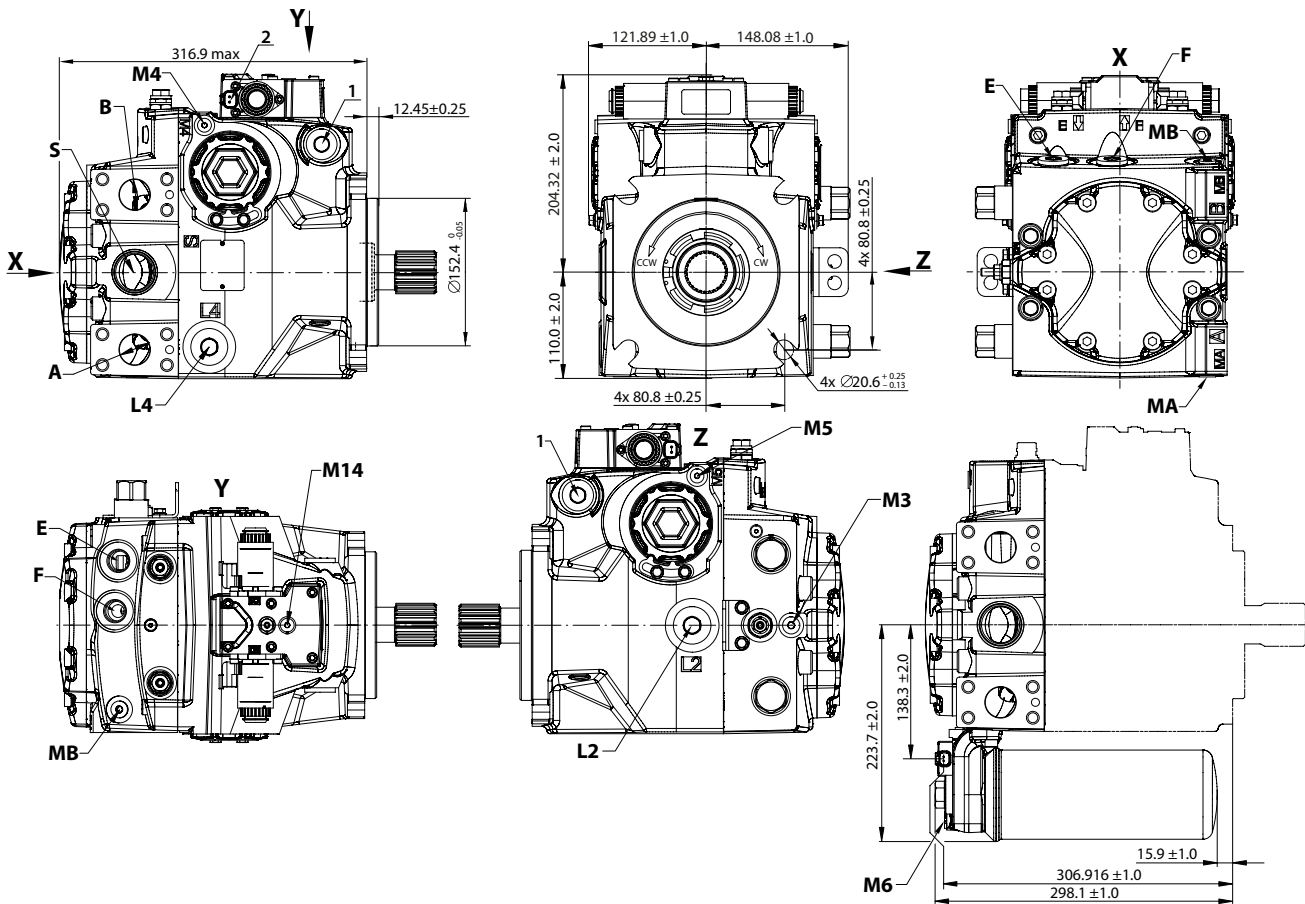
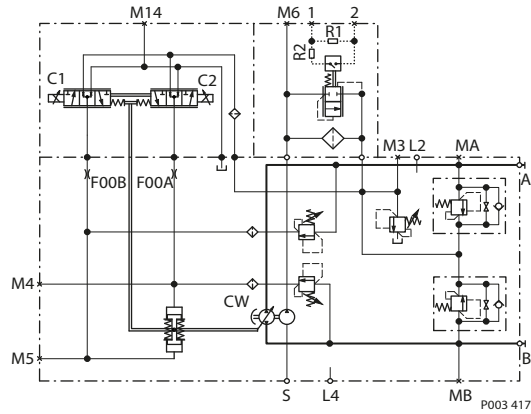

A/B system ports: Ø31.5 mm; M12 x 1.75; 20 min. full thread depth

MA/MB (system), **M3, M6** (charge) gauge ports per ISO 11926-1: 9/16-18

M4, M5 (servo), **M14** (case) gauge ports per ISO 11926-1: 7/16-20

L2, L4 – Case drain ports per ISO 11926-1: 1 5/16-12

E/F – Charge filtration ports per ISO 11926-1: 1 1/16-12

S – Charge inlet port per ISO 11926-1: 1 5/8-12 (SAE O-ring boss)

1 – Case pressure port per ISO 11926-1: 1 1/16-2

2 – Connector DEUTSCH DT04-2P, to be paint free

Danfoss can accept no responsibility for possible errors in catalogues, brochures and other printed material. Danfoss reserves the right to alter its products without notice. This also applies to products already on order provided that such alterations can be made without subsequent changes being necessary in specifications already agreed. All trademarks in this material are property of the respective companies. Danfoss and the Danfoss logotype are trademarks of Danfoss A/S. All rights reserved.