

Data Sheet

H1 Bent Axis Variable Displacement Motor

Size 160 cm³

For more than 40 years, Danfoss has been developing state-of-the-art components and systems for mobile machinery used in off-highway operations around the world.

We have become a preferred supplier by offering the best of what really matters: The hardware inside your vehicle application.

H1 servo-controlled hydrostatic pumps and bent axis variable motors are no exception.

The H1 product is built around an advanced control and available in a wide range of displacements. It is designed for quality and reliability and offers expanded functionality, greater total efficiency, and easy installation.

All H1 control and sensor options are PLUS+1[®] Compliant. PLUS+1[®] allows you to rapidly develop and customize electronic machine control. It opens up the future by combining machine controls and diagnostics in an integrated operating network.



Features

Designed for quality and reliability

- Proven and optimized 9 piston rotating group
- Single piece housing
- Electric components with IP67 & IP69K rating

Installation and packaging benefits

- Optimized for shortest length
- Standardized connector interface
- Integrated loop flushing device
- Radial or axial high pressure ports

Greater total efficiency

- Minimized losses
- Improved at high flow conditions

Wide range of controls

- Electric Two-position Control
- Electric Proportional Control
- Hydraulic Two-position Control
- Hydraulic Proportional Control
- Pressure Compensator Override
- Proportional Pressure Compensator Override
- Brake Pressure Defeat option
- Common controls across the entire motor family
- PLUS+1[®] Compliant control and sensor options

Expanded functionality

- Zero degree capability together with a high performance 32 degree maximum angle
- Enhanced control functions with proportional controls de-energized at minimum or maximum displacement
- Optional integrated speed sensor with
 - Dual redundant speed sensing
 - Direction indication
 - Temperature sensing
 - Wire fault detection

Comprehensive technical literature is online at www.danfoss.com

Technical specifications

Weight	SAE ISO 3019/1	61.9 kg [136.5 lb]
	DIN ISO 3019/2	59.3 kg [130.7 lb]
	Cartridge	54.7 kg [120.6 lb]
Output speed rated	Max. displacement	2600 min ⁻¹ (rpm)
	Min. displacement (6°)	4250 min ⁻¹ (rpm)
	0° displacement	4750 min ⁻¹ (rpm)
Max. output speed	Max. displacement	3300 min ⁻¹ (rpm)
	Min. displacement (6°)	5250 min ⁻¹ (rpm)
	0° displacement	5750 min ⁻¹ (rpm)
System pressure	Working	450 bar [6527 psi]
	Maximum	480 bar [6962 psi]
	Min. low loop	7.5 bar [109 psi]
Case pressure	Rated	3 bar [44 psi]
	Max.	5 bar [73 psi]
	Min.	0.3 bar [4 psi]

Schematic example

H1 bent axis motor with Electric Proportional Control

(De-energized = max. displacement)

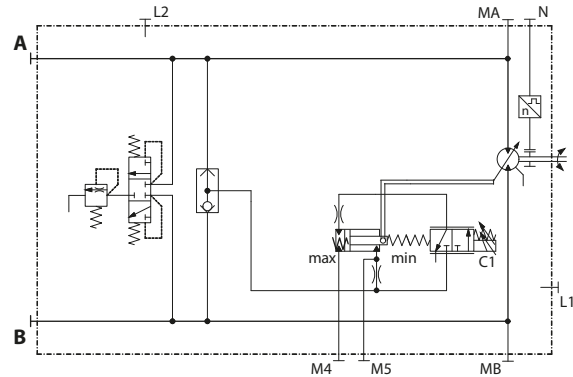

SAE ISO 3019/1 with Electric Proportional Control (de-energized = max. displacement)

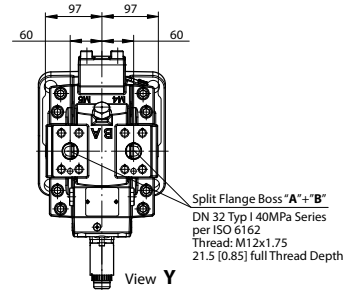
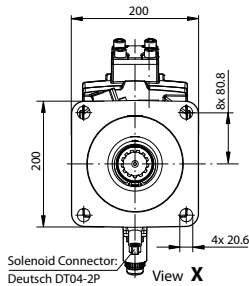
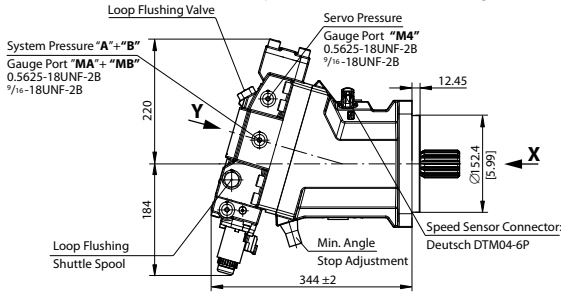

DIN ISO 3019/2 with Electric Proportional Control (de-energized = min. displacement)

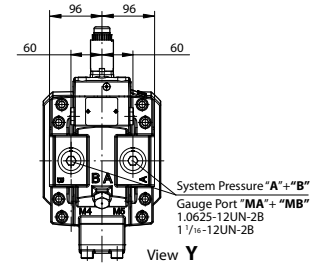
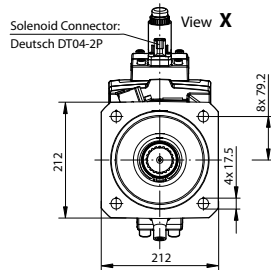
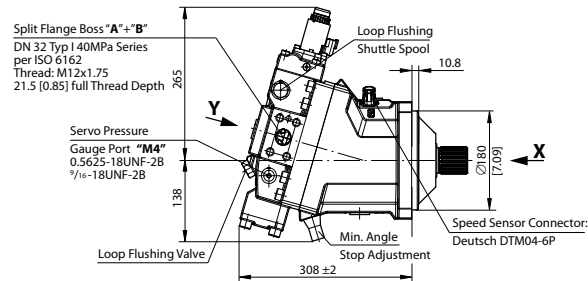

Cartridge with Electric Two-Position Control (de-energized = min. displacement) Pressure Compensator Override, Brake Pressure Defeat

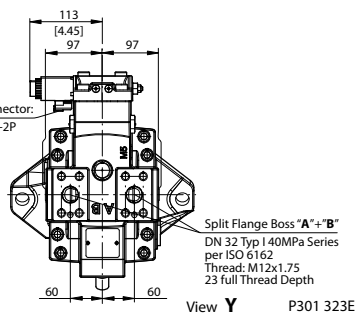
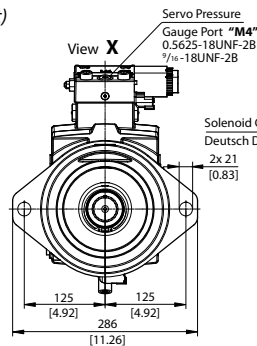
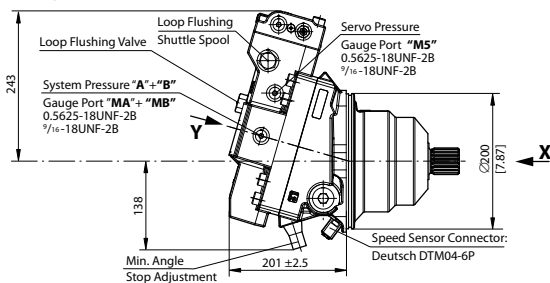

Danfoss can accept no responsibility for possible errors in catalogues, brochures and other printed material. Danfoss reserves the right to alter its products without notice. This also applies to products already on order provided that such alterations can be made without subsequent changes being necessary in specifications already agreed. All trademarks in this material are property of the respective companies. Danfoss and the Danfoss logotype are trademarks of Danfoss A/S. All rights reserved.