

Axial piston variable pump

A4VSO series 1x and 3x

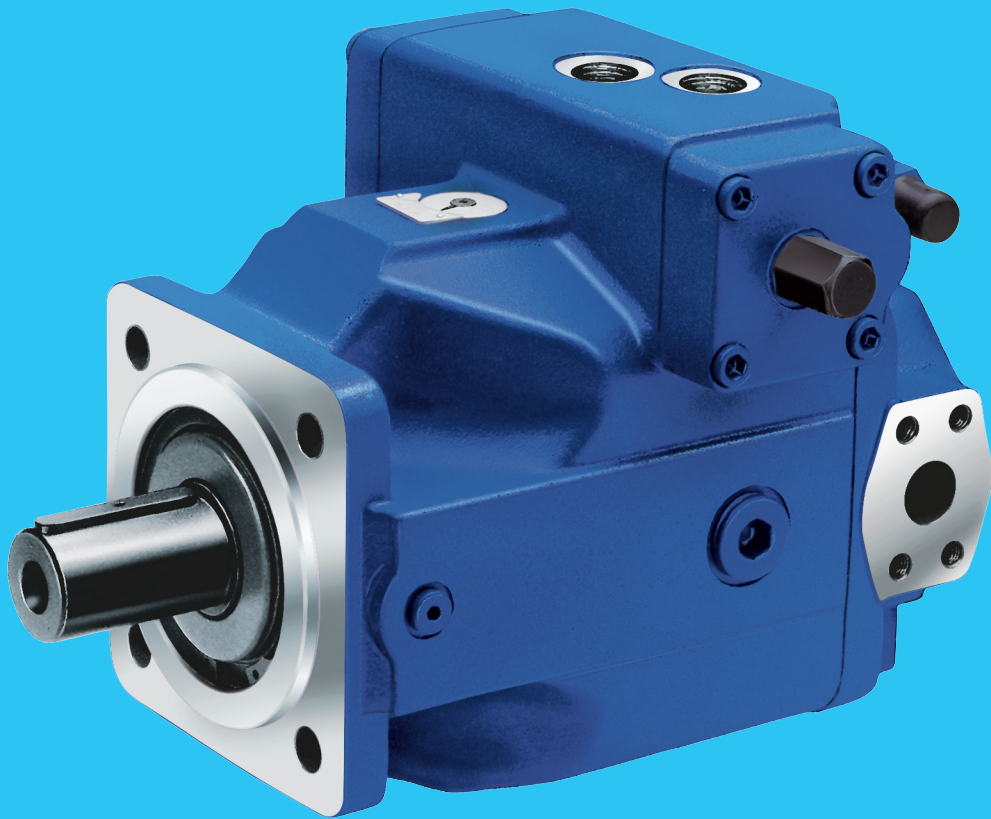

© Bosch Rexroth AG 2023. All rights reserved, also regarding any disposal, exploitation, reproduction, editing, distribution, as well as in the event of applications for industrial property rights.

The data specified within only serve to describe the product. As our products are constantly being further developed, no statements concerning a certain condition or suitability for a certain application can be derived from our information. The information given does not release the user from the obligation of own judgment and verification. It must be remembered that our products are subject to a natural process of wear and aging.

The cover shows an example application. The product delivered may differ from the image on the cover.

The original instruction manual was created in German.

Contents

1	About this documentation	5
1.1	Validity of the documentation.....	5
1.2	Required and supplementary documentation	5
1.3	Representation of information	6
1.3.1	Safety instructions	6
1.3.2	Symbols	7
1.3.3	Designations	8
1.3.4	Abbreviations	8
2	Safety instructions	9
2.1	About this chapter.....	9
2.2	Intended use	9
2.3	Improper use	9
2.4	Personnel qualifications	10
2.5	General safety instructions	11
2.6	Product-specific safety instructions	12
2.7	Personal protective equipment.....	14
3	General instructions on property damage and product damage.....	15
4	Scope of delivery.....	18
5	About this product	19
5.1	Performance description	19
5.2	Product description.....	19
5.2.1	Axial piston unit layout.....	19
5.2.2	Functional description.....	20
5.3	Product identification	21
6	Transport and storage	22
6.1	Transporting the axial piston unit.....	22
6.1.1	Transport by hand	22
6.1.2	Transport with lifting devices	23
6.2	Storing the axial piston unit	24
7	Installation.....	26
7.1	Unpacking	26
7.2	Installation conditions.....	26
7.3	Installation position	28
7.3.1	Below-reservoir installation (standard)	28
7.3.2	Inside-reservoir installation	29
7.3.3	Above-reservoir installation	30
7.4	Installing the axial piston unit	30
7.4.1	Preparation	30
7.4.2	Dimensions	32
7.4.3	General instructions	32
7.4.4	Installation with a coupling	32
7.4.5	Installation on a gearbox	33
7.4.6	Installation with cardan shaft.....	33
7.4.7	Completion of installation	34
7.4.8	Hydraulically connecting the axial piston unit	35
7.4.9	Electrically connecting the axial piston unit	41
7.5	Performing flushing cycle	41

8	Commissioning	42
8.1	Initial commissioning	42
8.1.1	Filling the axial piston unit.....	42
8.1.2	Testing the hydraulic fluid supply.....	44
8.1.3	Performing a functional test	44
8.2	Running-in phase.....	45
8.3	Recommissioning after standstill.....	45
9	Operation	46
10	Maintenance and repair	47
10.1	Cleaning and care	47
10.2	Inspection	48
10.3	Maintenance.....	48
10.4	Repair	49
10.5	Spare parts	49
11	Removal and replacement	50
11.1	Required tools.....	50
11.2	Preparing for removal.....	50
11.3	Performing the removal.....	50
11.4	Preparing the components for storage or further use	50
12	Disposal	51
13	Extension and conversion	52
14	Troubleshooting	53
14.1	How to proceed for troubleshooting.....	53
14.2	Malfunction table	54
15	Technical data	57
16	Alphabetical index	58

1 About this documentation

1.1 Validity of the documentation

This documentation applies to the following products:

- Axial piston variable pump A4VSO series 1x and 3x

This documentation is intended for machine/system manufacturers, assemblers and service engineers.

This documentation contains important information on the safe and proper transport, installation, commissioning, operation, maintenance, removal and simple troubleshooting of the axial piston unit.

- ▶ Read this documentation completely, in particular chapter 2 "Safety instructions" on page 9 and chapter 3 "General instructions on property damage and product damage" on page 15 before you start work with the axial piston unit.

1.2 Required and supplementary documentation

- ▶ Only commission the axial piston unit if the documentation marked with the book symbol  is available to you and you have understood and observed it.

Table 1: Required and supplementary documentation



















Title	Document number	Document type
 Order confirmation Contains the order-related technical data for your axial piston variable pump A4VSO.	–	Order confirmation
 Installation drawing Contains the outer dimensions, all ports and the hydraulic circuit diagram for your axial piston variable pump A4VSO.	Please request the installation drawing from your contact at Bosch Rexroth.	Installation drawing
 Axial piston variable pump A4VSO Contains the permissible technical data, ports, main dimensions and circuit diagrams of standard versions.	92050	Data sheet
 Axial piston variable pump A4VSO series 1X and 30 for HFC hydraulic fluids Contains the permissible technical data, ports, main dimensions and circuit diagrams of standard versions.	92053	Data sheet
 Control systems DR, DP, FR and DFR	92060	Data sheet
 Power controller LR2, LR3 and LR2N, LR3N	92064	Data sheet
 Control systems MA and EMA...	92072	Data sheet
 Control systems HM, HS, HS5 and EO	92076	Data sheet
 Control systems HD	92080	Data sheet
 DS2 secondary control	92057	Data sheet
 With DS3 secondary control	92059	Data sheet
 Electro-hydraulic control system DFE1x	92088	Data sheet
 Pressure and flow control system (Type SYHDFEE, SYHDFED, SYHDFEF)	30035	Data sheet

Table 1: Required and supplementary documentation

Title	Document number	Document type
 Hydraulic fluids based on mineral oils and related hydrocarbons Describes the requirements for mineral oil-based hydraulic fluids and related hydrocarbons for operation with Rexroth hydraulic components and provides support for selection of suitable hydraulic fluids for the hydraulic system.	90220	Data sheet
 Environmentally acceptable hydraulic fluids Describes the requirements for environmentally acceptable hydraulic fluids on mineral oil basis and related hydrocarbons for operation with Rexroth hydraulic components, and provides support for selection of suitable hydraulic fluids for the hydraulic system.	90221	Data sheet
 Fire-resistant, water-free hydraulic fluids (HFDR/HFDU) Describes the requirements on fire-resistant, water-free hydraulic fluids (HFDR/HFDU) for operation with Rexroth hydraulic components and assists you in selecting a hydraulic fluid for your hydraulic system.	90222	Data sheet
 Fire-resistant hydraulic fluids – containing water (HFAE, HFAS, HFB, HFC) Describes the requirements on fire-resistant, water-containing hydraulic fluids (HFAE, HFAS, HFB, HFC) for operation with Rexroth hydraulic components and assists you in selecting a hydraulic fluid for your hydraulic system.	90223	Data sheet
 Bosch Rexroth Fluid Rating List for Rexroth hydraulic components (pumps and motors) Contains the hydraulic fluids positively evaluated by Bosch Rexroth.	90245	Data sheet
Information on the application of hydrostatic drives at low temperatures Contains additional information on the application of Rexroth axial piston units at low temperatures.	90300-03-B	Manual
Storage and preservation of axial piston units Contains additional information on storage and preservation.	90312	Data sheet

1.3 Representation of information

Uniform safety instructions, symbols, terms and abbreviations are used throughout this documentation to ensure safe and proper use of the product. For clarification, they are explained in the sections below.

1.3.1 Safety instructions



This documentation contains safety instructions in chapter 2.6 "Product-specific safety instructions" on page 12 and in chapter 3 "General instructions on property damage and product damage" on page 15, as well as before a sequence of actions or an instruction for action involving a risk of personal injury and property damage. Always follow the measures for danger prevention associated with the use of this product.

Safety instructions are set out as follows:

 SIGNAL WORD
<p>Type and source of danger!</p> <p>Consequences of non-compliance</p> <ul style="list-style-type: none"> ▶ Danger prevention measures

- **Warning sign:** draws attention to the danger
- **Signal word:** identifies the degree of the danger
- **Type and source of danger:** indicates the type and source of the danger
- **Consequences:** describes the consequences of non-compliance
- **Precautions:** states how the danger can be avoided

Table 2: Hazard classes as defined in ANSI Z535.6

Warning sign, signal word	Meaning
 DANGER	Identifies a dangerous situation that will result in death or serious injury if it is not avoided.
 WARNING	Identifies a dangerous situation that may result in death or serious injury if it is not avoided.
 CAUTION	Identifies a dangerous situation that may result in minor to moderate injury if it is not avoided.
NOTICE	Property damage: The product or surrounding area may be damaged.

1.3.2 Symbols

The following symbols indicate notices that are not safety-relevant but increase understanding of the documentation.

Table 3: Meaning of symbols

Symbol	Meaning
	If this information is disregarded, the product cannot be used and/or operated to its full extent.
▶	Single, independent action
1.	Numbered instruction:
2.	The numbers indicate that the actions must be completed in order.
3.	

1.3.3 Designations

This documentation uses the following designations:

Table 4: Designations

Designation	Meaning
A4VSO	Axial piston variable pump, open circuit
Threaded plug	Metal screw, pressure-resistant
Protective plug	Made out of plastic, not pressure-resistant, only for transportation

As generic term for "axial piston variable pump A4VSO", the designation "axial piston unit" will be used in the following.

1.3.4 Abbreviations

This documentation uses the following abbreviations:

Table 5: Abbreviations

Abbreviation	Meaning
ANSI	A merican N ational S tandards I nstitute is an organization that coordinates the development of voluntary standards in the United States
ATEX	EC directive on explosion protection (A tmosphère e xplosible)
DIN	D eutsches I nstitut für N ormung (German Institute for Standardization)
DR	D ruckregler (pressure controller)
HS5M	Digital electro-hydraulic pump control system (suitable for use under hydraulic fluid)
ISO	I nternational O rganization for S tandardization
JIS	J apan I ndustrial S tandard
LR	L Leistungsregler (power controller)
RE	R exroth document in the E nglish language
VDI 2230	Guideline for the systematic calculation of heavy-duty threaded connections and cylindrical screw joints from the VDI (V erein D eutscher I ngenieur e - Association of German Engineers)

2 Safety instructions

2.1 About this chapter

The axial piston unit has been manufactured to generally accepted engineering standards. There is still, however, a risk of personal injury or property damage if this chapter and the safety instructions in this documentation are not observed.

- ▶ Read this documentation completely and thoroughly before working with the axial piston unit.
- ▶ Keep this documentation in a location where it is accessible to all users at all times.
- ▶ Always include the required documentation when you pass the axial piston unit on to third parties.

2.2 Intended use

Axial piston units are hydraulic components, meaning that in their application area they are classified neither as complete nor as partly completed machinery in the sense of the EC Machinery Directive 2006/42/EC. The component is exclusively intended to form partly completed machinery or complete machinery together with other components. The component should only be commissioned after it has been installed in the machine/system for which it is intended, and the safety of the entire system has been established in accordance with the Machinery Directive. This product is intended for the following use:

The axial piston unit is only approved as a pump for hydrostatic drives in an open circuit.

- ▶ Observe the technical data, the application and operating conditions and the performance limits as specified in the data sheet 92050 and in the order confirmation. Information about approved hydraulic fluids can be found in data sheet 92050.

The axial piston unit is only intended for commercial use and not for private use. Intended use includes having fully read and understood this documentation, especially chapter 2 "Safety instructions" on page 9.

2.3 Improper use

Any use other than that described as intended use is considered improper. Bosch Rexroth AG is not liable for damage resulting from improper use. The user is solely responsible for any risks arising from improper use.

The following foreseeable forms of faulty usage are also considered improper (this list is not exhaustive):

- Use outside the operating parameters approved in the data sheet and in the order confirmation (unless specifically approved by the customer)
- Use of non-approved fluids, e.g. water or polyurethane components
- Changes to factory settings by unauthorized persons.

- Use of assembled parts (e.g. control unit, valves) not in combination with the specified Rexroth components
- Use of the axial piston unit with assembled parts under water at a depth of more than 10 meters without the necessary additional measures, e.g. pressure equalization. Units with electrical components (e.g. sensors) must not come into contact with water, depending on the IP protection class. Observe the IP protection class in the data sheet 92050.
- Use of the axial piston unit under a continuous pressure differential between housing and ambient pressure greater than 4 bar absolute, with the case pressure always greater than the external pressure on the shaft seal ring (ambient pressure). Momentary ($t < 0.1$ s) case pressure peaks of up to 6 bar absolute are acceptable. Beyond this, the maximum permissible case pressure specified in the data sheet should not be exceeded.
- Application of the axial piston unit in explosive environments unless the component or machine/system has been certified as compliant with the ATEX Directive 2014/34/EU
- Use of the axial piston unit in a corrosive atmosphere
- Use of the axial piston unit in aircraft or spacecraft

2.4 Personnel qualifications

The activities described in this documentation require a basic understanding of mechanics, electricity and hydraulics, as well as familiarity with associated technical terms. For transporting and handling the product, knowledge regarding the use of lifting devices and lifting accessories is required. In order to ensure safe use, these activities should only be performed by skilled personnel or an instructed person under the direction and supervision of skilled personnel.

Skilled personnel refers to persons who possess the professional training, knowledge and experience, as well as the understanding of the regulations relevant to the work to be done that are necessary to recognize possible dangers and take the appropriate safety measures. Skilled personnel must follow the rules relevant to their field and have the necessary hydraulic expert knowledge.

Hydraulic expert knowledge includes:

- Being able to read and fully understand hydraulic circuit diagrams
- In particular, fully understanding the relationships with regard to safety devices
- Knowledge regarding the function and interaction of hydraulic components



Bosch Rexroth offers you measures supporting training in specific areas.

You can find an overview of the training contents on the Internet at:

www.boschrexroth.com/training.

2.5 General safety instructions

- Observe the country-specific accident prevention and environmental protection regulations.
- Observe the safety regulations of the country in which the product is used/operated.
- Use Rexroth products only when they are in good working order.
- Observe all notices on the product.
- Do not assemble, operate, remove or maintain Rexroth products if under the influence of alcohol, drugs or medication that may affect your reaction time.
- Only use genuine Rexroth accessories and spare parts to ensure there is no hazard to persons from unsuitable spare parts.
- Observe the technical data and ambient conditions specified in the product documentation.
- If unsuitable products are installed or used in safety-relevant applications, unexpected operating conditions may occur in the application, which could result in personal injury or property damage. For this reason, only use the product in safety-relevant applications if this use is expressly indicated and approved in the product documentation, e. g. in explosion protection areas or in safety-related parts of a control system (functional safety).
- Only commission the product if it has been determined that the end product (e.g. machinery/system) in which the Rexroth products are installed complies with the country-specific provisions, safety regulations and standards for the application.
- Use tools appropriate for the work being performed and wear appropriate protective clothing to prevent punctures and cuts (e.g. when removing protective covers, disassembly).
- There is a risk of entanglement when operating the axial piston unit with a bare shaft end. Check whether or not your machine requires additional safety measures for your application. If necessary, make sure these are appropriately implemented.
- Depending on the type of control used, electromagnetic effects can be produced when using solenoids. Applying a direct voltage signal (DC) to solenoids does not create electromagnetic interference (EMI) nor is the solenoid affected by EMI. Potential electromagnetic interference (EMI) exists if the solenoid is energized with a modulated direct current (e.g. PWM signal). Appropriate testing and measures should be taken by the machine manufacturer to ensure other components or operators (e.g. with pacemaker) are not affected by this potential.

2.6 Product-specific safety instructions

The following safety instructions apply to chapters 6 to 14.

WARNING

Danger due to excessive pressure!

Risk of death or injury, or property damage!

Improperly changing the factory pressure settings can result in a pressure increase beyond the permissible maximum pressure.

Operating the unit above the maximum permissible pressure can cause components to burst and hydraulic fluid to escape under high pressure.

- ▶ Changes to the factory settings may only be made by Bosch Rexroth specialists.
- ▶ Pressure cut-off and/or pressure control (hydraulic or electronic) is not an adequate safeguard against pressure overload. Therefore, a pressure relief valve must be provided in the hydraulic system (integrated into the pump or externally in the system). In this connection, observe the technical limits of the pressure relief valves.

Danger due to suspended loads!

Risk of death or injury, or property damage!

Improper transportation may cause the axial piston unit to fall down and lead to injury, e.g. crushing or fracture, or damage to the product.

- ▶ Make sure that the load bearing capacity of the lifting device is sufficient to safely bear the weight of the axial piston unit.
- ▶ Never step or grip under suspended loads.
- ▶ Ensure a stable transport position.
- ▶ Use your personal protective equipment (e.g. safety goggles, safety gloves, suitable working clothes, safety shoes).
- ▶ Use suitable lifting devices for transport.
- ▶ Observe the prescribed position of the lifting strap.
- ▶ Observe the national laws and regulations on occupational health and safety, and transportation.

System/machine under pressure!

Risk of death or serious injury when working on unsecured machines/systems!

Property damage!

- ▶ Switch off the relevant machine/system part and secure it against reactivation according to the parameters by the machine/system manufacturer.
- ▶ Ensure that all relevant components of the hydraulic system are depressurized. For this purpose, observe the parameters indicated by the machine/system manufacturer.
- ▶ Please note that the hydraulic system might still be pressurized even after separation from the actual pressure supply.
- ▶ Do not disconnect any line connections, ports or components as long as the hydraulic system is under pressure.

 **WARNING****Escaping hydraulic fluid mist!**

Risk of explosion and fire hazard, health hazard, risk of environmental pollution!

- ▶ Depressurize the relevant machine/system component and repair the leak.
- ▶ Only perform welding work when the machine/system is depressurized.
- ▶ Keep open flames and ignition sources away from the axial piston unit.
- ▶ If axial piston units are located in the vicinity of ignition sources or powerful thermal radiators, a shield must be erected to ensure any escaping hydraulic fluid cannot be ignited, and to protect hose lines from premature aging.

Escaping hydraulic fluid due to leakage of machine/system components!

Risk of burning and risk of injury due to escaping hydraulic fluid jet!

In case of leakage at the axial piston unit, high-pressure fluid jets may escape.

- ▶ Depressurize the relevant machine/system component and repair the leak.
- ▶ Never attempt to block or seal the leak or hydraulic fluid jet with a cloth.

Hydraulic fluid will explode when making contact with water!

Explosion and fire hazard!

- ▶ Do not bring hot hydraulic fluids in contact with water.

Electrical voltage!

Danger to life or risk of injury due to electric shock or property damage!

- ▶ Always disconnect the voltage supply to the relevant machine/system part before installing the product and/or connecting or disconnecting the connector. Protect the machine/system against being re-energized.

Restriction of control function!

Risk of injury or property damage!

Under certain circumstances, moving parts in control equipment (e.g., valve spools) can get stuck in an undefined position due to contamination (e.g., impure hydraulic fluid, abrasion or residual dirt from components). As a result, the hydraulic fluid flow and the build-up of torque in the axial piston unit can no longer respond correctly to the operator's specifications. Even the use of various filter elements (external or internal flow filtration) will not rule out a fault but merely reduce the risk.

- ▶ Check whether your application requires remedial measures on your machine in order to bring the driven consumer to a safe position (e.g. safe stop).
- ▶ If necessary, make sure these are appropriately implemented.

 **CAUTION****High noise development during operation!**

Risk of hearing damage or hearing loss!

The noise emission of axial piston units depends on rotational speed, working pressure and installation conditions, among other factors. The sound pressure level may rise above 70 dB (A) in certain application conditions.

- ▶ Always wear hearing protection near a running axial piston unit.

Hot surfaces on axial piston unit!

Risk of getting burnt!

- ▶ Allow the axial piston unit to cool down sufficiently before touching it.
- ▶ Wear heat-resistant, protective clothing, e.g. gloves.

Improper cable and line routing!

Risk of stumbling and property damage! Improper routing of cables and lines can cause a risk of stumbling as well as damage to equipment and components, e.g. due to lines and connectors being torn off.

- ▶ Always lay cables and lines so no one can trip over them, they do not become kinked or twisted, do not rub on edges and do not run through sharp-edged ducts without adequate protection.

Contact with hydraulic fluid!

Risk of adverse health effects, e.g. eye injury, skin irritation, toxication from inhalation!

- ▶ Avoid any contact with hydraulic fluids.
- ▶ When handling hydraulic fluids, the safety instructions of the manufacturer need to be observed at all times.
- ▶ Use your personal protective equipment (e.g. safety goggles, safety gloves, suitable working clothes, safety shoes).
- ▶ Immediately seek medical attention, however, if hydraulic fluid gets into your eyes or blood circuit or if you swallow it accidentally.

Danger from improper handling!

Risk of slipping and property damage! Risk of slipping when climbing on the axial piston unit. Parts and components may be damaged.

- ▶ Never grab or climb onto the axial piston unit.
- ▶ Check how to safely get on top of the machine/system.

2.7 Personal protective equipment

Personal protective equipment is the responsibility of the user of the axial piston unit. Observe the safety regulations in your country.

All pieces of personal protective equipment must be intact.

3 General instructions on property damage and product damage

The following information applies to chapters 6 to 14.

NOTICE

Danger from improper handling!

Product can be damaged!

- ▶ Do not subject the product to improper mechanical loads.
- ▶ Never use the product as handle or step.
- ▶ Do not put/place any objects on the product.
- ▶ Do not strike the drive shaft of the axial piston unit.
- ▶ Do not set/place the axial piston unit on the drive shaft or assembled parts.
- ▶ Do not strike assembled parts (e.g. sensors, solenoids or valves).
- ▶ Do not hit sealing surfaces (e.g. on the work connections).
- ▶ Leave the protective covers on the axial piston unit until you connect the lines.
- ▶ Disconnect all electrical connectors before arc welding and painting operations.
- ▶ Make sure the electronic components (e.g. sensors) do not build up electrostatic charges (e.g. during painting operations).

Risk of property damage due to inadequate lubrication!

Product can be damaged or destroyed!

- ▶ Never operate the axial piston unit with insufficient hydraulic fluid. Specifically, make sure that the rotary group has sufficient lubrication.
- ▶ When commissioning a machine/system, make sure that the housing area and the working lines of the axial piston unit are filled with hydraulic fluid and remain filled during operation. Avoid air inclusions in the forward drive shaft bearing, especially with the axial piston unit installed with the drive shaft upward.
- ▶ Check the hydraulic fluid level in the housing area regularly and replenish, if necessary. For above-reservoir installation, the housing area may drain out through the drain line after prolonged standstill periods (air enters through the shaft seal) or through the working line (gap leakage). This means the bearings are insufficiently lubricated when the system is turned on.
- ▶ Make sure the suction line is always filled with hydraulic fluid during commissioning and operation.
- ▶ Ensure in case of above-reservoir installation that before initial start-up of the axial piston pump (commissioning or recommissioning), the suction line is completely filled with hydraulic fluid. Make sure that the axial piston pump does suck in hydraulic fluid and build up pressure in the system directly after start-up. In case of longer standstill period, suitable measures have to be taken to prevent draining of the suction line.

NOTICE

Mixing hydraulic fluids!

Product can be damaged!

- ▶ Before installation, remove all fluids from the axial piston unit to prevent mixing with the hydraulic fluid used in the machine/system.
- ▶ Any mixture of hydraulic fluids of different manufacturers and/or different types of the same manufacturer is generally not permissible.

Contamination of hydraulic fluid!

The cleanliness of the hydraulic fluid considerably impacts the service life of the axial piston unit. Contamination of the hydraulic fluid may lead to premature wear and malfunctions!

- ▶ Always ensure a work environment in the assembly location that is free from dust and foreign particles to prevent foreign particles, e.g. welding beads or metal cuttings, from entering the hydraulic lines and lead to wear and malfunctions in the product. The axial piston unit should be clean when installed.
- ▶ Only use clean ports, hydraulic lines and assembled parts (e.g. measuring devices).
- ▶ When plugging the ports, no contamination must ingress.
- ▶ Before commissioning, ensure that all hydraulic connections are tight and that all seals and plugs of the plug-in connection are correctly installed and undamaged to prevent fluids and foreign particles from entering the product.
- ▶ Filter the hydraulic fluid when filling the system with a suitable filter system to minimize the solid particle contamination and water in the hydraulic system and to achieve the required cleanliness level.

Improper cleaning!

Product can be damaged!

- ▶ Plug all openings with appropriate protective covers in order to prevent cleaning agents from entering the axial piston unit.
- ▶ Never use solvents or aggressive cleaning agents. Use only water and, if necessary, a mild cleaning agent to clean the axial piston unit.
- ▶ Do not point a high-pressure cleaner at sensitive components, e.g. shaft seal, electrical connections and components.
- ▶ Use fiber-free cleaning cloths for cleaning.

Environmental pollution due to improper disposal!

Careless disposal of the axial piston unit and its assembled parts, the hydraulic fluid and the packaging material can cause environmental pollution!

- ▶ Dispose of the axial piston unit, hydraulic fluid and packaging in accordance with the regulations in your country.
- ▶ Dispose of the hydraulic fluid in accordance with the applicable safety data sheet for the hydraulic fluid.

NOTICE

Danger from chemical or corrosive environmental conditions!

Product can be damaged! If the axial piston unit is exposed to chemical or corrosive environmental conditions, such as sea water, fertilizer or road salt, it can result in corrosion or, in extreme cases, malfunction. Leaks may lead to leakage of hydraulic fluid.

- ▶ Take appropriate measures to protect the axial piston unit from chemical or corrosive environmental conditions.

Leakage or spilling of hydraulic fluid!

Risk of environmental pollution and contamination of ground water!

- ▶ Always place a drip tray under the axial piston unit when filling and draining hydraulic fluid.
- ▶ Use a suitable binding agent to collect any leaked hydraulic fluid.
- ▶ Observe the parameters in the safety data sheet for the hydraulic fluid and the specifications provided by the machine/system manufacturer.

Danger from hot components!

Nearby products can be damaged! Components which heat up (e.g., solenoids) can cause damage to nearby products if they are too close during installation.

- ▶ When installing the axial piston unit, check the safety distances to nearby products to ensure that they are not damaged.

The warranty only applies to the machine configuration as delivered.

The warranty will be voided if the product is incorrectly installed, commissioned or operated, or if it is used or handled improperly.

4 Scope of delivery

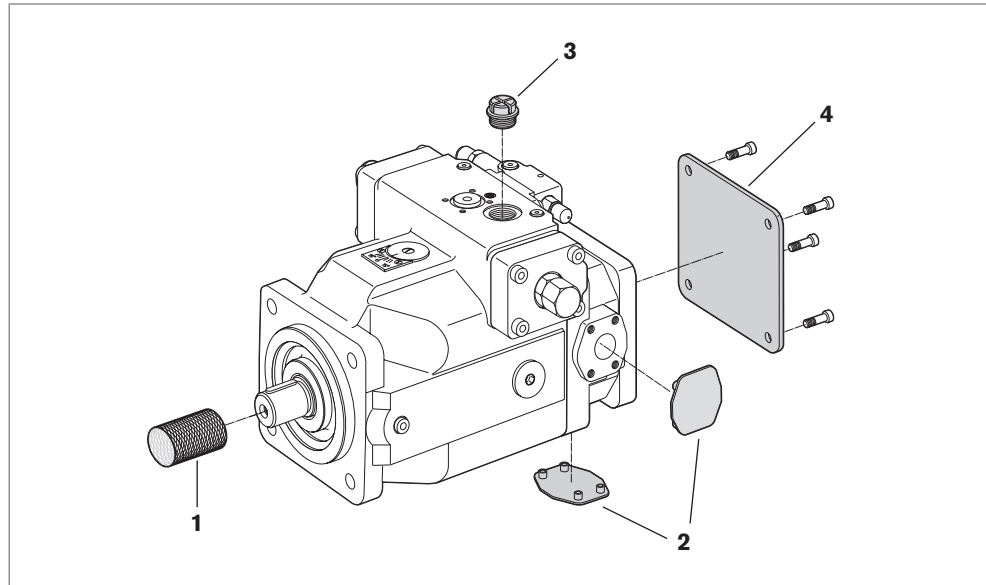

Fig. 1: Axial piston unit

Included in the scope of delivery:

- Axial piston unit as per order confirmation

The following parts come assembled on the unit:

- Transport protection for drive shaft end **(1)**
- Protective covers **(2)**
- Protective plug/threaded plugs **(3)**
- For version with through drive, protective cover incl. mounting bolts **(4)**

5 About this product

5.1 Performance description

The axial piston variable pump generates, controls and regulates a hydraulic fluid flow. It is designed for stationary applications.

Refer to data sheet 92050 and the order confirmation for the technical data, operating conditions and application limits of the axial piston unit.

5.2 Product description

The A4VSO is a variable pump with axial piston rotary group of swashplate design for hydrostatic drives in an open circuit hydraulic system.

Flow is proportional to drive speed and displacement.

The flow can be continuously adjusted by controlling the swashplate (cradle) **(13)**.

For axial piston units with swashplate design, the pistons **(11)** are arranged axially to the drive shaft **(1)**.

Open circuit

In an open circuit, the hydraulic fluid flows from the reservoir to the hydraulic pump from where it is fed to the consumer, e.g. hydraulic motor. From the consumer, the hydraulic fluid flows directly back to the reservoir.

5.2.1 Axial piston unit layout

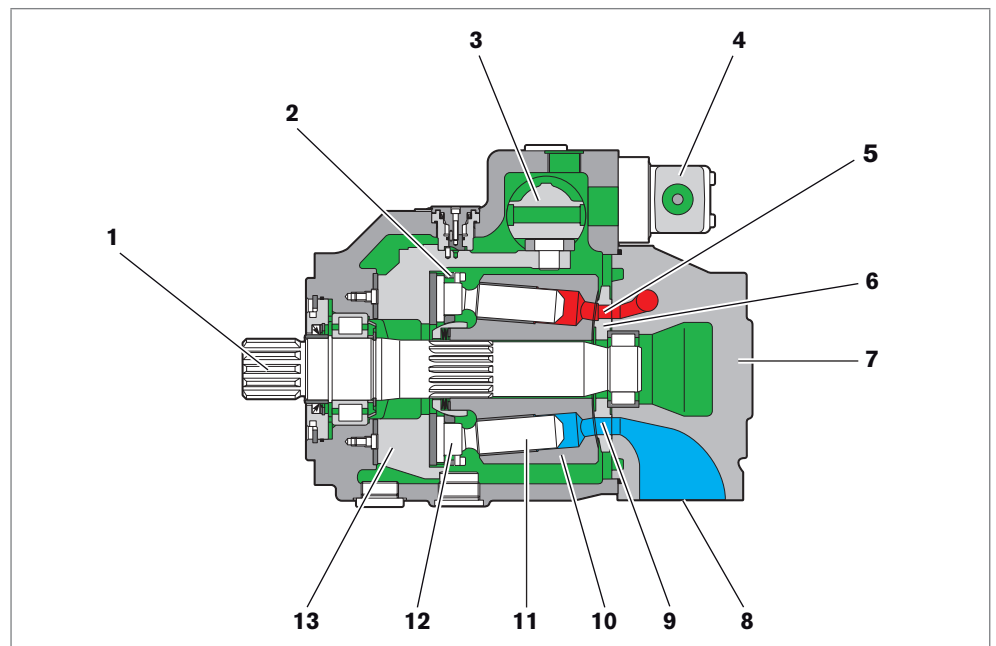

Fig. 2: Layout of the A4VSO

1 Drive shaft	5 High-pressure side	10 Cylinder
2 Retaining plate	6 Distributor plate	11 Piston
3 Stroking piston	7 Port plate	12 Slipper pad
4 Control unit (here DR as example)	8 Suction port	13 Swashplate (cradle)
	9 Suction side	

5.2.2 Functional description

Pump Torque and rotational speed are applied to the drive shaft **(1)** by a drive motor. The cylinder **(10)** is picked up and turned by the splines of the drive shaft. With every revolution, the pistons **(11)** complete a stroke in the cylinder bores, the size of which depends on the pitch of the cradle **(13)**. The slipper pads **(12)** are held on with the pistons and guided along the glide surface of the cradle by the retaining plate **(2)**. The pitch of the swashplate during a revolution causes each piston to move over the bottom and top dead centers and back to its initial position. During this sequence, hydraulic fluid is fed in and drained out through the two control slots in the distributor plate **(6)** according to displacement. On the suction side **(9)** hydraulic fluid flows into the piston chamber as the piston recedes. At the same time, on the high-pressure side **(5)** the hydraulic fluid is pushed out of the cylinder chamber into the hydraulic system by the pistons.

Control The swivel angle of the cradle **(13)** is infinitely variable. Controlling the swivel angle changes the piston stroke and, with it, the displacement. The swivel angle is controlled hydraulically by the stroking piston **(3)**. The cradle is mounted for easy motion in swivel bearings. Increasing the swivel angle increases the displacement; reducing the angle reduces displacement accordingly. The swivel angle should not be set to zero to provide sufficient volume of hydraulic fluid for

- cooling of the pistons,
- supply of the control,
- compensation of leakage, and
- lubrication of all moving parts

your disposal.



Various control devices are available depending on requirements. Information about this can be found in data sheet 92050.

5.3 Product identification

The axial piston unit can be identified by the name plate. The following example shows an A4VSO name plate:

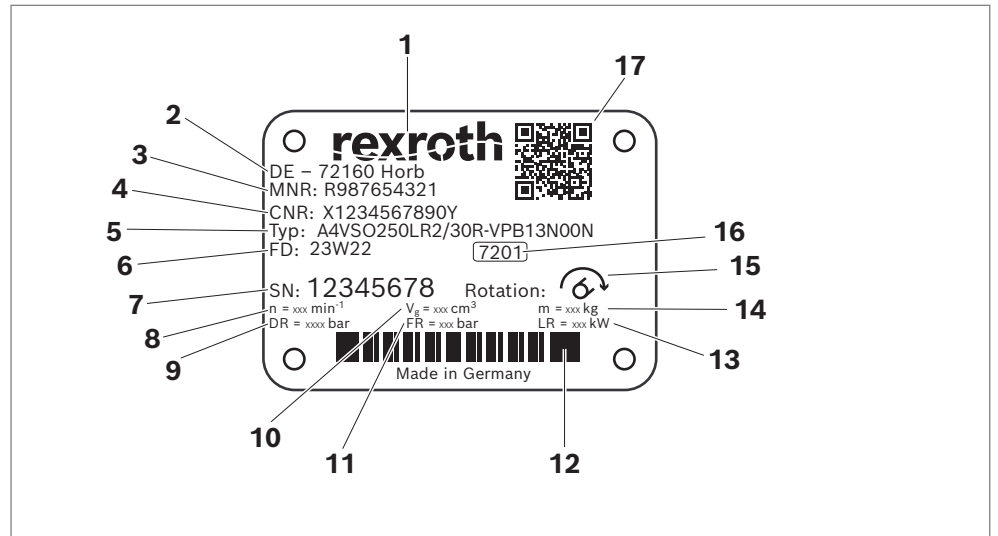

Fig. 3: Name plate A4VSO

- | | |
|---|---|
| 1 Trademark | 11 Flow controller setting (optional) |
| 2 Company address | 12 Barcode |
| 3 Material number of the axial piston unit | 13 Power controller setting (optional) |
| 4 Customer material number (optional) | 14 Net weight (optional) |
| 5 Type code | 15 Direction of rotation (viewed on drive shaft) – here: clockwise |
| 6 Manufacturing date | 16 Internal ID |
| 7 Serial number | 17 QR code |
| 8 Rotational speed (optional) | |
| 9 Pressure controller setting (optional) | |
| 10 Displacement (optional) | |

6 Transport and storage

- ▶ Always observe the required ambient conditions for transport and storage; see chapter 6.2 "Storing the axial piston unit" on page 24.



Information on unpacking can be found in chapter 7.1 "Unpacking" on page 26.

6.1 Transporting the axial piston unit

The following transportation options are available depending on weight and duration of transport:

- Transport by hand
- Transporting with a lifting device (eye bolt or lifting strap)

Dimensions and weights

Table 6: Dimensions and weights

Size		40	71	125	180	250	355	370	500	750	750 ¹⁾	1000
Weight	kg	39	53	88	102	184	207	207	320	460	490	605
Width	mm	Dimensions vary by equipment. The values applicable for your axial piston unit can be found in the installation drawing (request if necessary).										
Height	mm											
Depth	mm											

¹⁾ With charge pump (A4VSLO)

Weight may vary by equipment.

6.1.1 Transport by hand

Up to a specific maximum weight, axial piston units can be transported by hand for a short distance. Observe the national regulations in your country. To prevent health damage, we recommend renouncing any transport by hand.

CAUTION! Risk of injury due to heavy loads!

Health hazard from carrying axial piston units.

- ▶ Only manually transport the axial piston unit for a short period of time. Observe the national regulations in your country for manual transport.
- ▶ Always use appropriate lifting, lowering and moving techniques.
- ▶ Use your personal protective equipment (e.g. safety goggles, safety gloves, suitable working clothes, safety shoes).
- ▶ Do not transport the axial piston unit by sensitive assembled parts (e.g. sensors or valves).
- ▶ Carefully place the axial piston unit on the seating to prevent it from being damaged.

6.1.2 Transport with lifting devices

For transporting, the axial piston unit can be connected to a lifting device via an eye bolt or a lifting strap.

Transporting with eye bolt

The axial piston unit can be transported suspended from an eye bolt screwed into the drive shaft as long as only outward (pulling) axial forces are applied.

- ▶ For all female threads, use a stud end from the same system of units and of the correct size.
- ▶ To do this, screw an eye bolt completely into the female thread on the drive shaft. The thread size is indicated in the installation drawing.
- ▶ Make sure that the eye bolt can bear the total weight of the axial piston unit plus 20%.

You can lift the axial piston unit as shown in Fig. 4 with the eye bolt screwed into the drive shaft.

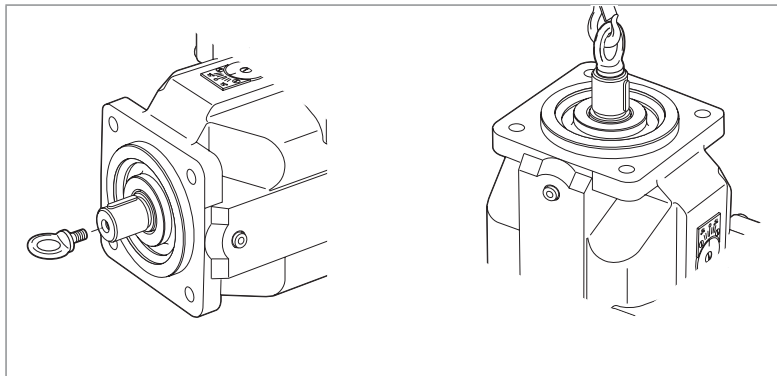

Fig. 4: Mounting the eye bolt

Transport with lifting strap

WARNING! Danger due to suspended loads!

During transport with lifting strap, the axial piston unit can topple out of the lifting strap and cause injury.

- ▶ Use the widest possible lifting strap.
- ▶ Make sure that the axial piston unit is securely fixed with the lifting strap.
- ▶ Only guide the axial piston unit by hand for fine positioning and to avoid swinging.
- ▶ Never step or grip under suspended loads.
- ▶ Place the lifting strap around the axial piston unit in such a way that it does not pass over assembled parts (e.g. valves, piping) and that the axial piston unit is not suspended from assembled parts (see Fig. 5).

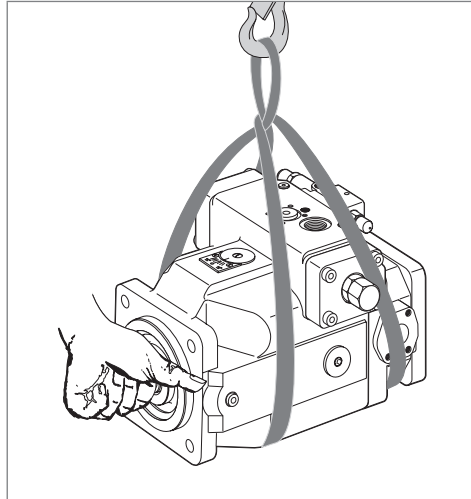

Fig. 5: Transport with lifting strap

6.2 Storing the axial piston unit

Requirement

- Storage areas should be free of corrosive materials and gases.
 - To prevent damage to the seals, do not operate ozone-forming equipment (e.g. mercury-vapor lamps, high-voltage equipment, electric motors, sources of electrical sparks or electrical discharge) in storage areas.
 - Storage areas should be dry.
Recommended relative humidity $\leq 60\%$.
 - Ideal bearing temperature: $+5\text{ °C}$ to $+20\text{ °C}$.
 - Minimum storage temperature: -50 °C .
 - Maximum storage temperature: $+60\text{ °C}$.
 - Keep out of direct sunlight.
 - Do not stack axial piston units and store them in a shock-proof manner.
 - Do not store the axial piston unit on the drive shaft or assembled parts, e.g. sensors or valves.
 - For further storage conditions, see Table 7.
- Check the axial piston unit monthly to ensure professional storage.

After delivery

The axial piston units come in corrosion protection packaging (corrosion protection film) provided at the factory.

Table 7 lists the maximum permissible storage times for an unpackaged axial piston unit as per data sheet 90312.

Table 7: Storage time with factory-supplied corrosion protection

Storage conditions	Standard corrosion protection	Long-term corrosion protection (optional)
Closed, dry room, uniform temperature between $+5\text{ °C}$ and $+20\text{ °C}$. Undamaged and closed corrosion protection film.	Maximum 12 months	Maximum 24 months



The warranty will be voided if the requirements and storage conditions are not observed or after expiration of the max. storage time (see Table 7).

How to proceed once the max. storage time elapses:

1. Check the entire axial piston unit for damage and corrosion prior to installation.
2. Perform a test run to check the axial piston unit for proper functioning and leak-tightness.
3. If storage time exceeds 24 months, replace the shaft seal.



Once the max. storage time has elapsed, we recommend that you have the axial piston unit checked by your Bosch Rexroth service partner.

For questions regarding repair and spare parts, contact your proper Bosch Rexroth service partner or the service department of the manufacturer's plant of the axial piston unit, see chapter 10.5 "Spare parts" on page 49.

After removal

An uninstalled axial piston unit must be preserved with corrosion protection for the duration of storage.



The following instructions only refer to axial piston units operated with a mineral oil-based hydraulic fluid. Other hydraulic fluids require other specific preservation measures. In such a case, consult your local contact person; you can find their contact information at <https://addresses.boschrexroth.com>

Bosch Rexroth recommends the following procedure:

1. Clean the axial piston unit; see chapter 10.1 "Cleaning and care" on page 47.
2. Drain the axial piston unit.
3. For storage times up to 12 months: Moisten the inside of the axial piston unit with mineral oil and fill with approx. 100 ml mineral oil.
For storage times up to 24 months: Fill the axial piston unit with VCI corrosion protection oil (20 ml).
The unit is filled through the drain port **K₁** or **K₂**, see chapter 7.4 "Installing the axial piston unit", Fig. 10 to 38 on page 38.
4. Plug all ports so they are airtight.
5. Coat unpainted areas of the axial piston unit with mineral oil or suitable, easily removable corrosion protection, e.g. acid-free grease.
6. Pack the axial piston unit with desiccant in an airproof manner in corrosion protection film.
7. Store the axial piston unit in a shock-proof manner; see "Requirement" on page 24 in this chapter.

7 Installation

Prior to installation, the following documents should be to hand:

- Data sheet of the axial piston unit (contains the permissible technical data, main dimensions and circuit diagrams of standard versions)
- Installation drawing for the axial piston unit (can be obtained from your contact person at Bosch Rexroth, if required)
- Hydraulic circuit diagram for the axial piston unit (in the data sheet and on the installation drawing)
- Hydraulic circuit diagram for the machine/system (available from the machine/system manufacturer upon request)
- Order confirmation (contains the order-related technical data for your axial piston unit)

7.1 Unpacking

The axial piston unit comes in a polyethylene material (PE) corrosion protection film.

CAUTION! Danger due to falling parts!

If the packaging is not opened correctly, parts may fall out and damage the parts or even result in injury.

- ▶ Place the packaging on a level underground with sufficient load-bearing capacity.
- ▶ Only open the packaging from the top.

- ▶ Remove the packaging from the axial piston unit.
- ▶ Check the axial piston unit for transport damage and completeness; see chapter 4 "Scope of delivery" on page 18.
- ▶ Dispose of the packaging in accordance with the regulations in your country.

7.2 Installation conditions

The installation position and location of the axial piston unit essentially determine how it is installed and commissioned (such as when filling and air bleeding the axial piston unit).

- ▶ Fasten the axial piston unit so that the expected forces and torque can be transferred without any danger. The machine/system manufacturer is responsible for sizing the fastening elements.
- ▶ Observe the permissible radial forces on the drive shaft when driving with radial loading (belt drives). If necessary, store the belt pulley separately.
- ▶ Make sure the axial piston unit is always filled with hydraulic fluid during commissioning and operation. Also do this also after relatively long standstill periods, since the axial piston unit may drain out through the hydraulic lines.
- ▶ Direct the leakage in the housing area to the reservoir through the highest drain port. Use a line size that matches the port.

- ▶ A check valve in the drain line is only permissible on a case-by-case basis following consultation. Please consult your proper contact person at Bosch Rexroth.
- ▶ To prevent the transmission of structure-borne noise, use elastic elements to decouple all connecting lines from all vibration-capable components (e.g. reservoir, frame parts).
- ▶ Make sure the suction, leakage, and return lines flow into the reservoir below the minimum fluid level under all operating conditions. This will prevent air from being drawn in and foam from forming.
- ▶ When designing the reservoir, ensure that there is adequate distance between the suction line and the drain line. We recommend using a baffle (baffle plate) between suction line and drain line. A baffle improves the air separation ability as it gives the hydraulic fluid more time for desorption. Apart from that, this prevents the heated return flow from being drawn directly back into the suction line. The suction port must be supplied with filtered, cooled, calmed and degassed hydraulic fluid over a sufficient period of time.
- ▶ Make sure that a minimum suction pressure of 0.8 bar absolute (without charge pump) or 0.7 bar absolute (with charge pump) absolute is present at port **S** during operation and at cold start, in all installation positions and installation locations for the axial piston pump, see Fig. 6. See data sheet for other pressure values.

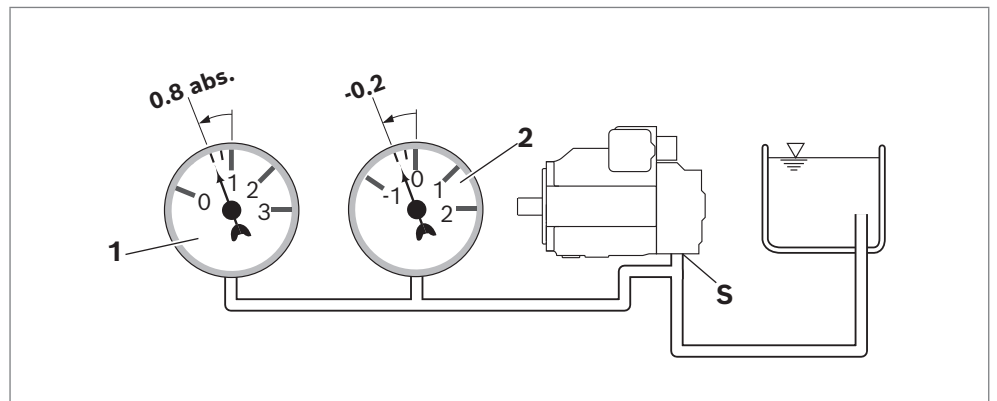

Fig. 6: Suction pressure

- 1** Absolute pressure gauge
- 2** Standard pressure gauge (relative)



The suction conditions improve with below-reservoir installation and inside-reservoir installation.

- ▶ Make sure that the working environment at the installation site is completely free of dust and foreign substances. The axial piston unit should be clean when installed. Contamination of the hydraulic fluid can considerably affect the function and service life of the axial piston unit.
- ▶ When using pump carriers with the installation position "drive shaft upward", dirt can accumulate on the shaft seal, which can lead to leaks. Particularly in case of highly contaminated ambient conditions, any potentially present air bleed bores in the pump carrier should be plugged in compliance with applicable standards and safety regulations. Apart from that, regular checks and/or cleaning is necessary. Observe the information in chapter 10.1 "Cleaning and care" on page 47 and Table 10 "Inspection schedule" on page 48.

- ▶ Use fiber-free cleaning cloths for cleaning.
- ▶ Use suitable, mild cleaning agents to remove lubricants and other heavy contamination. Do not allow cleaning agents to enter into the hydraulic system.

7.3 Installation position

The following installation positions are permissible. The pipeline routing shown illustrates the basic layout.



Recommended installation position: 1 and 2.



Port **F** is part of the external piping and must be provided on the customer side to make filling and air bleeding easier.

Key	
R(L) (F)	Filling/air bleeding
S	Suction port
T	Drain port
U	Flushing port
K ₁ , K ₂	Flushing port
SB	Baffle (baffle plate)
$h_{t\ min}$	Minimum required immersion depth (200 mm)
h_{min}	Minimum required distance to reservoir bottom (100 mm)
$h_{S\ max}$	Maximum permissible suction height (800 mm)

A4VSO units for HFC hydraulic fluids

For A4VSO units for HFC hydraulic fluids according to data sheet 92053, the following restrictions apply:

- In case of variant "F" (type code position 07), external bearing flushing is always required.
- For variant "F2" (type code position 07), external bearing flushing is not required at permissible installation positions "F2".

7.3.1 Below-reservoir installation (standard)

Below-reservoir installation means that the axial piston unit is installed outside of the reservoir below the minimum fluid level.

Installation position 1

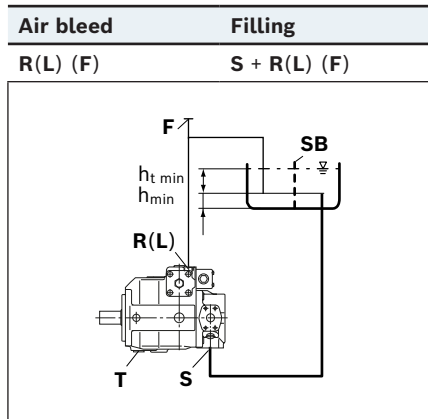

Installation position 2

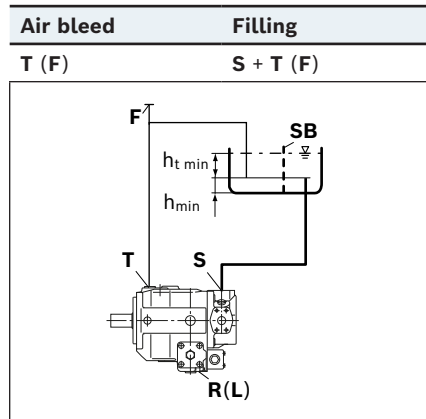

Installation position 3

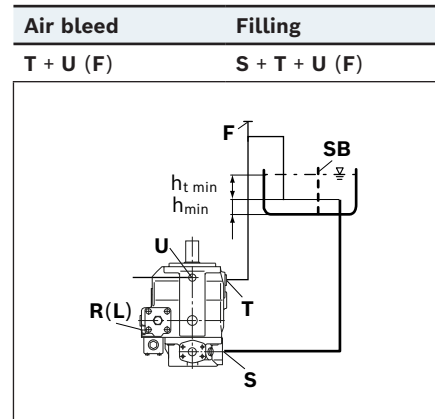

7.3.2 Inside-reservoir installation**NOTICE****Risk of damage with inside-reservoir installation!**

To prevent damage to the axial piston unit, all plastic parts (e.g. protective plugs, covers), except for the tamper-proof caps, must be removed prior to installation in the reservoir.

- ▶ Remove all plastic parts, except for the tamper-proof caps, before you install the axial piston unit in the reservoir. Make sure that no parts of them remain in the reservoir.
- ▶ Remove the protective plug from suction port **S** and open the highest leakage and/or flushing port.

Inside-reservoir installation is when the axial piston unit is installed in the reservoir below the minimum fluid level. The axial piston unit is completely below the hydraulic fluid.

If the minimum fluid level is equal to or below the upper edge of the pump, see chapter 7.3.3 "Above-reservoir installation" on page 30.



Axial piston units with electric components (e.g. electric controls, sensors) must not be installed in a reservoir below the fluid level.

If inside-reservoir installation is intended nevertheless, the IP protection class and the medium compatibility of the electric components used must be checked in the individual case. Please consult your proper contact person at Bosch Rexroth to commission an examination of the medium compatibility. The exception is control HS5M:

The proportional valve which is not included in scope of delivery can be positioned outside the reservoir in the system and piped up via the provided ports **X₁** and **X₂** of the pump.

The unit can be installed in the reservoir together with the position transducer mounted at the pump.

Approved for HLP fluids according to DIN 51524 only.



We recommend to provide the suction port **S** with a suction pipe and for the drain port **T** or **R(L)** to be piped. In this case, the other drain port must be plugged. When designing the reservoir, ensure that there is adequate distance between the suction line and the drain line. The housing of the axial piston unit must be filled before fitting the piping and filling the reservoir with hydraulic fluid. To prevent draining of the housing, the reservoir has to be filled with hydraulic fluid as soon as possible.

Installation position 4

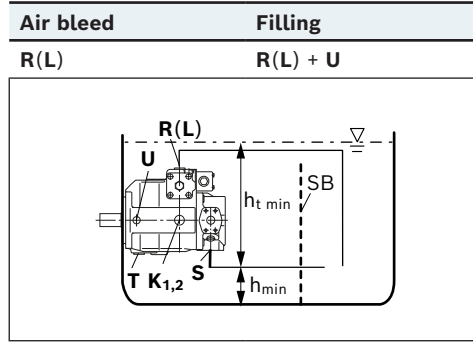

Installation position 5

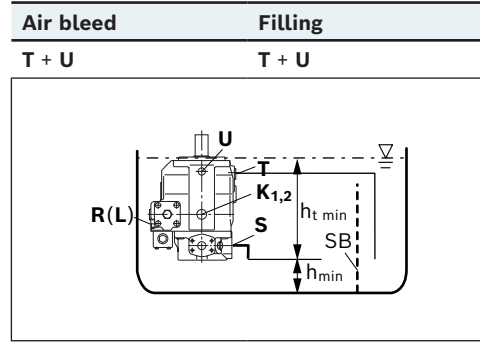

7.3.3 Above-reservoir installation

Above-reservoir installation means that the axial piston unit is installed above the minimum fluid level of the reservoir.



Observe the maximum permissible suction height $h_{s \max} = 800 \text{ mm}$.
The permissible suction height h_s is derived from the total pressure loss.



The above-reservoir installation is not recommended for sizes 180 to 1000 and is not permissible for units with charge pump (A4VSL0).

Installation position 6

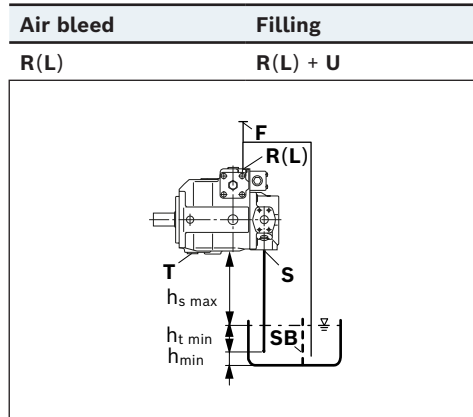

Installation position 7

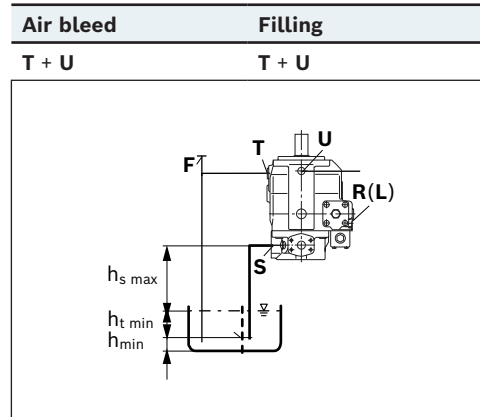

7.4 Installing the axial piston unit

7.4.1 Preparation

1. Check the specifications on the name plate to see you have the correct axial piston unit.
2. Compare the material number and designation (type code) with the parameters in the order confirmation.



If the material number for the axial piston unit does not match the one in the order confirmation, contact your local contact person for clarification. You can find their contact information at <https://addresses.boschrexroth.com>

3. Before installing, completely drain the axial piston unit to prevent mixing with the hydraulic fluid used in the machine/system.

4. Check the permissible direction of rotation of the axial piston unit (on the name plate) and make sure that this corresponds to the direction of rotation of the drive motor.

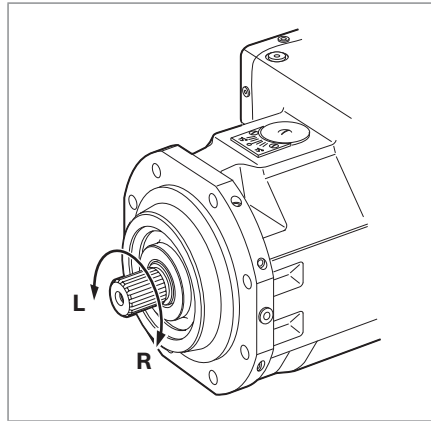

Fig. 7: Direction of rotation

- L** Counter-clockwise
R Clockwise



The direction of rotation as indicated on the name plate determines the direction of rotation of the axial piston unit as viewed on the drive shaft; see chapter 5.3 "Product identification" on page 21. For information on the direction of rotation of the drive motor, please refer to the drive motor manufacturer's instruction manual.

5. Check the swivel angle indicator on the axial piston unit.

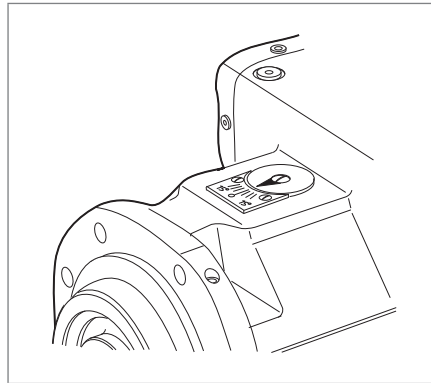

Fig. 8: Swivel angle indicator



Depending on the control, the axial piston unit always starts at $V_{g \max}$, $V_{g \min}$ or at 0. For information, see the data sheets listed for the respective controls, see Table 1 "Required and supplementary documentation" on page 5. Even if the optical swivel angle indicator is set to "0", there is a risk that the axial piston unit will swing out immediately after the drive has been switched on and will deliver hydraulic fluid.

7.4.2 Dimensions

For standard versions, the data sheet 92050 and the respective data sheet for control devices contain all required installation dimensions as well as the position and dimensions of the connections. If necessary, an installation drawing can be requested. Also observe the manuals provided by the manufacturers of the other hydraulic components when selecting the required tools.

7.4.3 General instructions

Follow these general notices when installing the axial piston unit:

- Note that certain installation positions will affect the control system. Gravity, dead weight and case pressure can cause minor characteristic shifts and changes in response time.
- Torsional vibrations and speed variations may cause increased rotary angular acceleration of the rotary group of the axial piston unit. At risk are diesel drives with a small number of cylinders and low flywheel mass and toothed belt or V-belt drives. Belts can lose much of their pre-charge pressure after just a short operating time.
An automatic clamping device can lessen the speed variations and vibrations, and thus avoid subsequential damage.
– When using drives with toothed belts or V-belts, always use an automatic clamping device.
- On the drive of an axial piston unit, a cardan shaft may cause vibrations and excessive rotary angular acceleration. Depending on the frequency and temperature, this may cause leaks in the shaft seal and damage the rotary group.
- If a shared drain line is used for several units, make sure that the respective case pressure in each unit is not exceeded. The shared drain line must be dimensioned to ensure that the maximum permissible case pressure of all connected units is not exceeded in any operating condition, particularly at cold start. If this is not possible, separate drain lines must be laid.

The version of installation for the axial piston unit depends on the connecting elements to the drive side. The following descriptions explain the installation of the axial piston unit:

- With a coupling
- On a gearbox
- On a cardan shaft

7.4.4 Installation with a coupling

The following describes how to install the axial piston unit with a coupling:

NOTICE! Danger from improper handling!

Product can be damaged!

- ▶ Do not install the coupling hub on the drive shaft of the axial piston unit by striking it.

1. Install the specified coupling half on the drive shaft of the axial piston unit according to the instructions of the coupling manufacturer.



The drive shaft of the axial piston unit is equipped with a female thread. Use this female thread to pull the coupling element onto the drive shaft. The size of the female thread can be seen in the installation drawing.

2. Make sure that the installation location is clean and free from dirt and foreign particles.
3. Clamp the coupling hub onto the drive shaft or ensure permanent lubrication of the drive shaft. This prevents the formation of frictional corrosion and the associated wear.
4. Transport the axial piston unit to the installation location.
5. Install the coupling on the output shaft of the drive motor in accordance with the specifications provided by the coupling manufacturer.



Do not fasten down the axial piston unit until the coupling has been correctly installed.

6. Fasten the axial piston unit at the installation location.
7. Align the drive shaft of the axial piston unit and the output shaft of the drive motor so there is no angular deviation.
Make sure no excessive axial and radial forces are acting on the drive shaft.
8. Details on the required tools and tightening torques for the mounting bolts are available from the machine/system manufacturer.

7.4.5 Installation on a gearbox

The following describes how to install the axial piston unit on a gearbox.

After installing on a gearbox, the axial piston unit is covered and is difficult to access:

- ▶ Before installing, make sure that the spigot diameter centers the axial piston unit (observe tolerances) and that no excessive axial or radial forces are acting on the drive shaft of the axial piston unit (installation length).
- ▶ Protect the drive shaft against frictional corrosion by ensuring permanent lubrication.
- ▶ Fasten the axial piston unit at the installation location.

For attachment via gear wheel or helical gear shaft

No spline forces higher than the permissible axial and radial forces should act on the shaft; if necessary, support the gear wheel at the gearbox output separately.

7.4.6 Installation with cardan shaft

Bring the axial piston unit to the installation position and fasten it. Details of the required tools and tightening torque for the mounting bolts can be obtained from the machine/system manufacturer.

NOTICE! Damage to the axial piston unit and leaks at the shaft seal due to incorrectly installed cardan shaft!

Improperly installed cardan shafts generate unbalances. This results in vibrations and inadmissible axial and radial forces on the drive shaft.

- ▶ Observe the cardan shaft manufacturer's assembly instructions.

7.4.7 Completion of installation

1. Remove any installed transport screws.

CAUTION! Operation with protective plugs!

Operating the axial piston unit with protective plugs may result in injury or damage to the axial piston unit.

- ▶ Before commissioning, remove all protective plugs and replace them with suitable, pressure-resistant, metal threaded plugs or connect the appropriate lines.

2. Remove the transport protection.

The axial piston unit comes with protective covers (2) and protective plugs (3). (2) and (3) are not pressure-resistant and have to be removed prior to connection. Use a suitable tool for this to prevent damage to the sealing and functional surfaces. If sealing or functional surfaces are damaged, contact your Bosch Rexroth service partner or the service department of the manufacturer's plant of the axial piston unit.

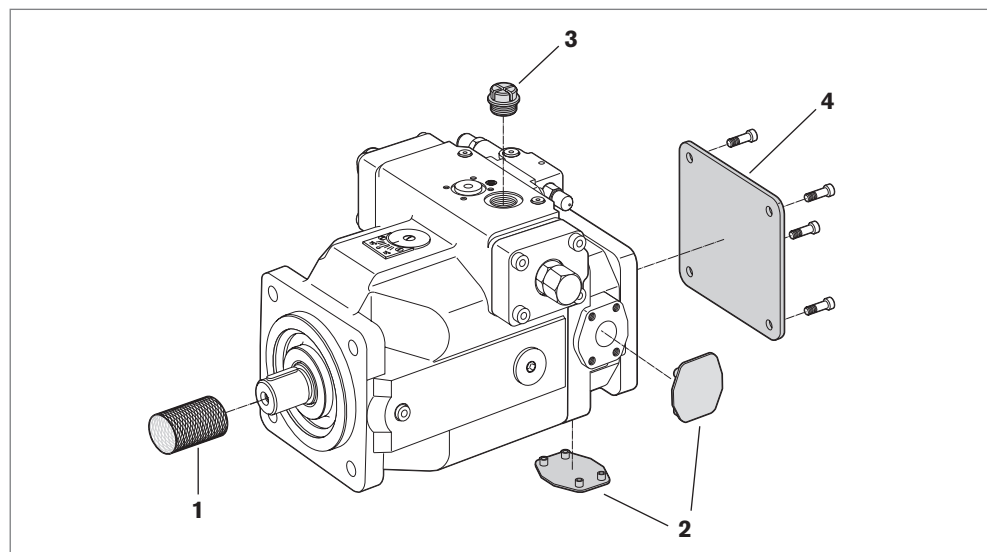

Fig. 9: Removing transport protection

- | | | | |
|---|--|---|---|
| 1 | Transport protection for drive shaft end | 4 | For version with through drive, protective cover and mounting bolts |
| 2 | Protective covers | | |
| 3 | Protective plugs/threaded plugs | | |



Ports intended for connecting lines come with protective plugs and/or threaded plugs, which serve as transport protection. Connect all ports required for functional operation (see Table 8 "Ports A4VSO series 1x and 3xSeries 1x and 3x" on page 38). Non-compliance could lead to malfunctions or damage. If a port is not being used, plug it with a threaded plug since the protective plugs are not pressure-resistant.



Adjusting the setting screws will render the warranty void. If you need to change the settings, please contact your local contact person; you can find their contact information at

<https://addresses.boschrexroth.com>

3. For versions with through drive, install the auxiliary pump according to the pump manufacturer's manual. The protective cover (4) is not pressure-resistant and therefore not permissible during operation.
For the design of the mounting bolts, observe VDI 2230 with $\mu = 0.1$ and screw grade 8.8.

7.4.8 Hydraulically connecting the axial piston unit

NOTICE

Insufficient suction pressure!

Generally, a minimum permissible suction pressure at port **S** is specified for axial piston pumps in all installation positions. If the pressure at port **S** drops below the specified values, damage may occur which may lead to the destruction of the axial piston pump!

- ▶ Make sure the required suction pressure is maintained. This is influenced by:
 - The piping (e.g. suction cross-section, pipe diameter, length of suction line)
 - The position of the reservoir
 - The viscosity of the hydraulic fluid
 - A filter element or check valve in the suction line (check the level of contamination of the filter element regularly)
 - The geodesic height of the place of use

The machine/system manufacturer is responsible for dimensioning of the lines. Connect the axial piston unit to the rest of the hydraulic system in accordance with the hydraulic circuit diagram of the machine/system manufacturer.

The ports and fastening threads are designed for the p_{\max} permissible pressures of the respective ports, see Table 8 "Ports A4VSO series 1x and 3xSeries 1x and 3x" on page 38. The machine/system manufacturer is required to ensure that the connecting elements and lines correspond to the specified application conditions (pressure, flow, hydraulic fluid, temperature) with the necessary safety factors.



Connect only hydraulic lines that match the axial piston unit port (pressure level, size, system of units).

Information on routing of lines

Observe the following information when routing the suction, pressure and drain lines.

- Lines and hoses should be assembled without pre-charge pressure so no further mechanical forces are applied during operation that will reduce the service life of the axial piston unit and, possibly, the entire machine/system.
- Use suitable seals as sealing material.
- Suction line (pipe or hose)
 - The suction line should be as short and straight as possible.
 - Measure the line cross section of the suction line so the pressure at the suction port does not drop below the minimum permissible pressure. Make sure the maximum suction pressure is not exceeded (e.g. when prefilling).
 - Make sure the connections and connecting elements are airtight.
 - The hose must be pressure-resistant, also to external air pressure.
- Pressure line
 - For the pressure lines, use only pipes, hoses and connecting elements rated for the working pressure range specified in data sheet 92050 (see Table 8).
- Drain line
 - Always route the drain lines so that the housing is constantly filled with hydraulic fluid and to ensure no air gets through the shaft seal, even during extended standstill periods.
 - The case pressure must never exceed the limit values specified for the axial piston unit in the data sheet.
 - The drain line inflow in the reservoir should always be below the minimum fluid level (see chapter 7.3 "Installation position" on page 28).
- If the axial piston unit is equipped with assembled screw fittings, do not remove them. Screw the stud end of the fitting directly into the installed fitting.

Risk of confusion with threaded connections

Axial piston units are used in application areas that use the metric system as well as the Anglo-American (imperial) and the Japanese measuring system (JIS – **J**apan **I**ndustrial **S**tandard). Various kinds of seals are also used. The system of units, the kind of seal and the size of female thread and stud ends (e.g. threaded plug) must all match.

There is a risk of confusion due to the limited ways of visually telling them apart.

WARNING! Leaky and bursting stud ends!

For fittings, if a stud end that does not match the system of units, kind of seal and size of the female thread is pressurized, the stud end may loosen itself or even be ejected from the hole in a projectile-like manner. This can result in serious injury and property damage. Hydraulic fluid can escape from this leakage point.

- ▶ Use the drawings (installation drawing) to determine the required stud end for each fitting.
- ▶ Make sure the right fittings, mounting bolts and threaded plugs are installed.
- ▶ For all female threads, use a stud end from the same system of units and of the correct size.

Port overview

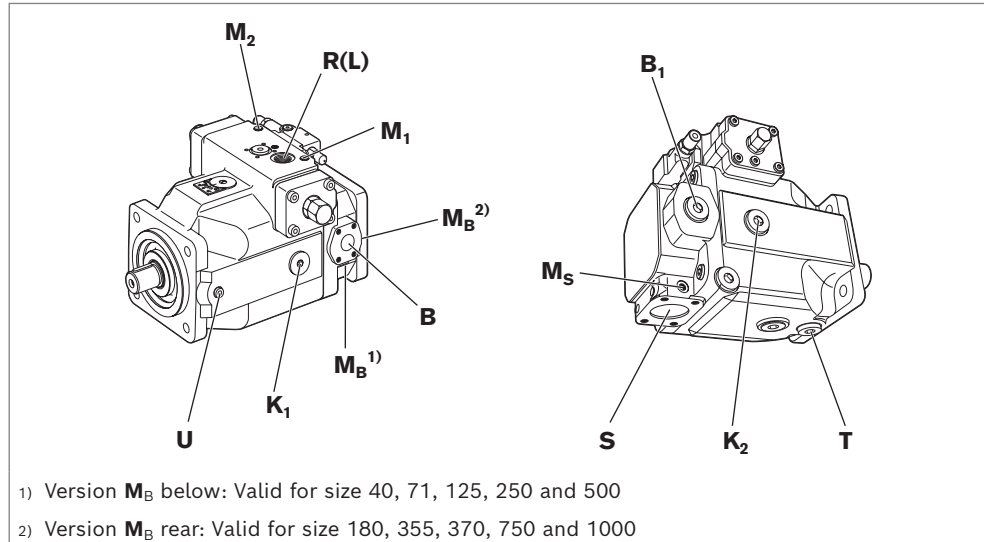

Fig. 10: Port overview A4VSO series 1x and 3x (standard ports)

Table 8: Ports A4VSO series 1x and 3x

Ports ¹⁾		p_{max} [bar] ²⁾	State ³⁾
S	Suction port (standard pressure series)	30	O
B	Pressure port (high-pressure series)	400	O
B⁴⁾	Pressure port (high-pressure series)	420	O
B₁⁵⁾	2nd working port (high-pressure series)	400	X ⁶⁾
B₁⁴⁾	2nd working port (high-pressure series)	420	X ⁶⁾
K₁, K₂	Flushing port	5	X ⁷⁾
T	Drain port	5	X ⁷⁾
M_B	Measuring port working pressure	400	X
M_S	Measuring port working pressure	30	X
R(L)	Drain port	5	O ⁷⁾
U	Flushing port	5	X
M₁, M₂	Measuring port (stroking chamber pressure)	400	X

- 1) The measuring system and thread size can be found in the installation drawing.
- 2) Depending on the application, momentary pressure peaks can occur. Keep this in mind when selecting measuring devices and fittings.
- 3) O = Must be connected (plugged on delivery)
X = Plugged (in normal operation)
- 4) Port plate version 36: available for sizes 370
- 5) Port plate version 25: available for all sizes
- 6) Plugged with flange plate
- 7) Depending on the installation position **T**, **K₁**, **K₂** or **R(L)** must be connected (see chapter 7.3 "Installation position" on page 28).

Tightening torques

The following tightening torques apply:

- Fittings:

Observe the manufacturer's specifications regarding the tightening torques of the fittings used.

- Female threads in the axial piston unit:

The max. permissible tightening torques $M_{G \max}$ are the maximum values for the female threads and should not be exceeded. For values, see Table 9.

- Threaded plugs:

For the metallic threaded plugs supplied with the axial piston unit, the required tightening torques of threaded plugs M_V apply. For values, see Table 9.

- Mounting bolts:

For mounting bolts with metric ISO threads according to DIN 13 and/or ASME B1.1 threads, we recommend checking the tightening torque in individual cases in accordance with VDI 2230.



In addition to the ports specified in Table 8 "Ports A4VSO series 1x and 3xSeries 1x and 3x" on page 38, axial piston units may have openings that are also closed with a threaded plug. These plugs must not be opened on the customer side! If you have opened the threaded plug accidentally, please contact your local contact person to ensure safe re-closing of the plug. You can find the address at

<https://addresses.boschrexroth.com>

Table 9: Tightening torques for female threads and threaded plugs

Ports Standard	Thread size	Maximum permissible tightening torque of female threads M_G max	Required tightening torque of threaded plugs M_V	WAF hexagon socket of the threaded plug
DIN 3852	M8 × 1	10 Nm	7 Nm ¹⁾	3 mm
	M10 × 1	30 Nm	15 Nm ²⁾	5 mm
	M12 × 1.5	50 Nm	25 Nm ²⁾	6 mm
	M14 × 1.5	80 Nm	35 Nm ¹⁾	6 mm
	M16 × 1.5	100 Nm	50 Nm ¹⁾	8 mm
	M18 × 1.5	140 Nm	60 Nm ¹⁾	8 mm
	M22 × 1.5	210 Nm	80 Nm ¹⁾	10 mm
	M26 × 1.5	230 Nm	120 Nm ¹⁾	12 mm
	M27 × 2	330 Nm	135 Nm ¹⁾	12 mm
	M33 × 2	540 Nm	225 Nm ¹⁾	17 mm
	M42 × 2	720 Nm	360 Nm ¹⁾	22 mm
	M48 × 2	900 Nm	400 Nm ¹⁾	24 mm
ISO 11926	5/16-24 UNF-2B	10 Nm	7 Nm	1/8 in
	3/8-24 UNF-2B	20 Nm	10 Nm	5/32 in
	7/16-20 UNF-2B	40 Nm	18 Nm	3/16 in
	9/16-18 UNF-2B	80 Nm	35 Nm	1/4 in
	3/4-16 UNF-2B	160 Nm	70 Nm	5/16 in
	7/8-14 UNF-2B	240 Nm	110 Nm	3/8 in
	1 1/16-12 UN-2B	360 Nm	170 Nm	9/16 in
	1 5/16-12 UN-2B	540 Nm	270 Nm	5/8 in
	1 5/8-12 UN-2B	960 Nm	320 Nm	3/4 in
1 7/8-12 UN-2B	1200 Nm	390 Nm	3/4 in	

1) The tightening torques for the threaded plugs are valid for the condition "dry" and "lightly oiled".

2) The tightening torques for the threaded plugs are valid for the condition "dry" – in the condition "lightly oiled", the tightening torques for M10 × 1 are reduced to 10 Nm and for M12 × 1.5 to 17 Nm.

- Procedure** To connect the axial piston unit to the hydraulic system:
1. Remove the protective plugs and/or threaded plugs from the ports where the connections should be made according to the hydraulic circuit diagram.
 2. Make sure the sealing surfaces of the hydraulic ports and functional surfaces are not damaged.
 3. Use only clean hydraulic lines or flush them before installation.
(Observe chapter 7.5 "Performing flushing cycle" on page 41 when you flush the hydraulic system.)
 4. Connect the lines in accordance with the installation drawing and the machine or system circuit diagram. Check that all ports are connected or plugged with threaded plugs. For inside-reservoir installation, the housing of the axial piston unit must be filled before fitting the lines and filling the reservoir with hydraulic fluid.
 5. Properly tighten the fittings (observe tightening torques!). Mark all properly tightened fittings, e.g. with a permanent marker.
 6. Check all pipes and hose lines and every combination of connecting pieces, couplings or connecting points with hoses or pipes to ensure they are in safe working condition.

7.4.9 Electrically connecting the axial piston unit**NOTICE****Short circuit due to penetrating hydraulic fluid!**

Fluid can penetrate the product and cause a short circuit!

- ▶ Do not install axial piston units with electric components (e.g. electric controls, sensors) in a reservoir below the fluid level (inside-reservoir installation) unless they have been explicitly released for use under hydraulic fluid, e. g. HS5M (see also chapter 7.3.2 "Inside-reservoir installation" on page 29).

The machine/system manufacturer is responsible for electric control layout. Electrically controlled axial piston units must be connected in accordance with the electrical circuit diagram for the machine/system.

In case of axial piston units with electric control and/or mounted sensors, observe the specifications according to data sheet 92050 and the respective data sheets for control devices (see Table 1 "Required and supplementary documentation" on page 5) with regard to the following exemplary electrical characteristics:

- Permissible voltage range
- Permissible current
- Correct pin assignment
- Recommended electrical control units

Detailed information on the connector, the type of protection and the appropriate mating connector can also be found in data sheet 92050 and the respective data sheets on control devices (see Table 1 "Required and supplementary documentation" on page 5). The mating connector is not included in the scope of delivery.

- Procedure**
1. Switch off the power supply to the relevant machine/system component.
 2. Electrically connect the axial piston unit (12 or 24 V). Before establishing the connection, check the connector and all seals for damage.

7.5 Performing flushing cycle

In order to remove foreign particles from the system, Bosch Rexroth recommends a flushing cycle for the hydraulic system before the first commissioning. To avoid internal contamination, do not include the axial piston unit in the flushing cycle.



Use an additional flushing unit to perform the flushing cycle. Follow the instructions of the flushing unit's manufacturer for the exact procedure during the flushing cycle.

8 Commissioning

WARNING

Danger while working in the danger zone of a machine/system!

Danger to life, risk of injury or serious injury!

- ▶ Pay attention to and eliminate potential danger sources before commissioning the axial piston unit.
- ▶ Make sure no one is in the danger zone of the machine/system.
- ▶ The emergency stop button for the machine/system should be within the operator's reach.
- ▶ Always follow the instructions of the machine/system manufacturer during commissioning.

CAUTION

Commissioning an incorrectly installed product!

Risk of injury and property damage!

- ▶ Make sure all electrical and hydraulic ports are connected or plugged.
- ▶ Commission only a fully installed, fully functioning product with original accessories from Bosch Rexroth.

8.1 Initial commissioning



During all commissioning work on the axial piston unit, observe the general safety instructions and intended use detailed in chapter 2 "Safety instructions" on page 9.

- ▶ Connect the pressure gauge for the working pressure, case pressure and suction pressure to the specified measuring points on the axial piston unit or in the hydraulic system, to check the technical data at first operation.
- ▶ During commissioning, monitor the temperature of the hydraulic fluid in the reservoir to ensure that it lies within permissible viscosity limits.

8.1.1 Filling the axial piston unit

Professional filling and air bleeding is required to prevent damage to the axial piston unit and to maintain proper function.



Usually, the cleanliness level of commercial hydraulic fluids is insufficient for the requirements of our components. These hydraulic fluids must be filtered during filling using an appropriate filter system to minimize solid particle contamination and water in the system.

Use only a hydraulic fluid that corresponds to the following requirements:

You can find details on the minimum requirements for hydraulic fluids in Rexroth data sheets 90220, 90221, 90222, and 90223. The titles of the data sheets can be found in Table 1 "Required and supplementary documentation" on page 5.



Bosch Rexroth evaluates hydraulic fluids on the basis of the Fluid Rating according to data sheet 90235. For hydraulic fluids which have been positively evaluated in the Fluid Rating, please refer to data sheet 90245 "Bosch Rexroth fluid rating list for Rexroth hydraulic components (pumps and motors)". Selection of hydraulic fluid shall make sure that the operating viscosity in the operating temperature range is within the optimum range (v_{opt} ; see selection diagram in the data sheet 92050).

To ensure the functional reliability of the axial piston unit, cleanliness level 20/18/15 according to at least ISO 4406 is required for the hydraulic fluid. At a hydraulic fluid viscosity of less than 10 mm²/s (e.g. due to high temperatures during short-term operation) at the drain port, a cleanliness level of at least 19/17/14 according to ISO 4406 is required. You can find parameters on the permissible and optimal viscosities and admissible temperatures in data sheet 92050.

Procedure Proceed as follows to fill the axial piston unit:

1. Place a drip tray under the axial piston unit to collect any hydraulic fluid that may leak.

NOTICE! Contaminated hydraulic fluid!

The cleanliness levels of commercial hydraulic fluids are usually insufficient for the requirements of our components.

- ▶ Use a suitable filter system to filter hydraulic fluids during filling to minimize solid particle contamination and water in the hydraulic system.
2. Fill and air bleed the axial piston unit via the appropriate ports; see chapter 7.3 "Installation position" on page 28. Also fill the hydraulic lines of the system.

NOTICE! Risk of property damage due to inadequate lubrication!

Product can be damaged or destroyed!

- ▶ When using a shut-off valve in the suction line, make sure that the drive of the axial piston unit can only be started when the shut-off valves are open.
 - ▶ Dimension a shut-off valve in the suction line so that no inadmissible pressure drop occurs in the suction area when the shut-off valve is open.
3. If you use a shut-off valve in the suction line, only operate the axial piston unit with opened shut-off valves.
 4. Test the direction of rotation of the drive motor. To do this, run the drive motor briefly at the lowest rotational speed (inching). Make sure that the direction of rotation of the axial piston unit agrees with the details of the name plate, see chapter 5.3 "Product identification", Fig. 3: Name plate A4VSO on page 21.

5. Operate the axial piston pump at a low rotational speed (starter speed for internal combustion engines and/or inching mode for electric motors) until the hydraulic system is completely filled and air bled. To verify, drain the hydraulic fluid at the drain port until there are no bubbles in the fluid.

8.1.2 Testing the hydraulic fluid supply

The axial piston unit should always have a sufficient supply of hydraulic fluid. For this reason, the supply of hydraulic fluid must be ensured at the start of the commissioning process.

When you test the hydraulic fluid supply, constantly monitor noise development and check the hydraulic fluid level in the reservoir. If the axial piston unit becomes louder (cavitation) or the leakage fluid is discharged with bubbles, this is an indication that the axial piston unit is not being sufficiently supplied with hydraulic fluid.

For information on troubleshooting, see chapter 14 "Troubleshooting" on page 53. To test the hydraulic fluid supply:

1. Allow the drive motor to run at the lowest rotational speed. The axial piston unit should be operated without load. Pay attention to leaks and noises.
2. Check the axial piston unit's drain line during the test. The leakage should be without bubbles.
3. Increase the load and check whether the working pressure rises as expected.
4. Perform a leak test to ensure the hydraulic system is sealed and can withstand the max. pressure.
5. Check the suction pressure at port **S** of the axial piston pump at nominal speed and max. swivel angle. Refer to data sheet 92050 for the permissible value.
6. At maximum working pressure, check the case pressure at port **K₁** or **K₂**. Refer to data sheet 92050 for the permissible value.

8.1.3 Performing a functional test

WARNING

Improperly connected axial piston unit!

Mixing up the ports will cause malfunctions (e.g. lift instead of lower) and could endanger personnel and equipment!

- ▶ Before the functional test, check whether the piping specified in the hydraulic circuit diagram has been installed.

Once you have tested the hydraulic fluid supply, perform a functional test of the machine/system. The functional test should be performed according to the instructions of the machine/system manufacturer.

The axial piston unit is tested for functional capability and performance before delivery according to the technical data. During commissioning, make sure the axial piston unit was installed in the machine/system as intended. Check with the swivel angle indicator that the axial piston unit swings in and out correctly during operation.

The position of the swivel angle indicator and assignment of the swivel direction to the direction of rotation and control can be found in the associated technical data sheets.

- ▶ After starting the drive motor, check in particular the specified pressures, e.g. working pressure and case pressure.
- ▶ Perform a leak test without and with load prior to normal operation.
- ▶ If necessary, remove the pressure gauge and plug the ports with the specified threaded plugs.

8.2 Running-in phase

NOTICE

Property damage due to insufficient viscosity!

Elevated hydraulic fluid temperature may excessively reduce viscosity and damage the product!

- ▶ Monitor the operating temperature during the running-in phase, e.g. by measuring the leakage temperature.
- ▶ Reduce the loading (pressure, rotational speed) of the axial piston unit if unacceptable operating temperatures and/or viscosities occur.
- ▶ Excessively high operating temperatures indicate faults that have to be analyzed and eliminated.

The bearings and sliding surfaces are subject to a running-in phase. The increased friction at the start of the running-in phase results in increased heat development which decreases with increasing operating hours. The mechanical-hydraulic efficiency is also greater until the running-in phase of about 10 operating hours is concluded.

To ensure that contamination in the hydraulic system does not damage the axial piston unit, Bosch Rexroth recommends the following procedure after the running-in phase:

- ▶ After the running-in phase, have a hydraulic fluid sample analyzed for the required cleanliness level.
- ▶ Change the hydraulic fluid if the required cleanliness level is not reached. If a laboratory test is not carried out after the running-in phase, Bosch Rexroth recommends changing the hydraulic fluid.

8.3 Recommissioning after standstill

Depending on the installation conditions and ambient conditions, changes may occur in the hydraulic system which make recommissioning necessary.

The following criteria may make recommissioning necessary:

- Air and/or water in the hydraulic system
 - Old hydraulic fluid
 - Other contamination
- ▶ Before recommissioning, proceed as described in chapter 8.1 "Initial commissioning" on page 42.

9 Operation

This product is a component which requires no settings or changes during operation. For this reason, this chapter of the manual does not contain any information on adjustment options. Use the product only within the performance range specified in the technical data. The machine/system manufacturer is responsible for proper project planning of the hydraulic system and its control.

10 Maintenance and repair

NOTICE

Overdue inspection and maintenance work!

Property damage!

- ▶ Perform the specified inspection and maintenance work at the intervals described in this manual.

10.1 Cleaning and care

NOTICE

Damage to seals and electrical system due to mechanical effects!

The jet of a high-pressure cleaner may damage the seals and electrical system of the axial piston unit!

- ▶ Do not point a high-pressure cleaner at sensitive components, e.g. shaft seal, electrical connections and components.

For cleaning and care of the axial piston unit, observe the following:

- ▶ Check whether all seals and plug-in connections are securely seated to ensure no moisture can penetrate into the axial piston unit during cleaning.
- ▶ Use only water and, if necessary, a mild cleaning agent to clean the axial piston unit. Never use solvents or aggressive cleaning agents.
- ▶ Remove major external contamination and keep clean sensitive and important components, such as solenoids, valves, indicators and sensors.

10.2 Inspection

In order for the axial piston unit to be reliable and long-lasting, Bosch Rexroth recommends inspecting the hydraulic system and axial piston unit on a regular basis, and documenting and archiving the following operating conditions:

Table 10: Inspection schedule

Tasks to be performed		Interval
Hydraulic system	Check hydraulic fluid level in the reservoir.	Daily
	Check the operating temperature under comparable load condition at the drain port and in the reservoir.	Weekly
	Perform hydraulic fluid analysis: Viscosity, aging and contamination	Yearly or every 2000 operating hours (whichever occurs first)
	Check filter. The replacement interval may vary depending on the cleanliness of the hydraulic fluid. We recommend using a contamination indicator.	Yearly or every 1,000 operating hours (whichever occurs first)
Axial piston unit	Check axial piston unit for leakage. Early detection of hydraulic fluid loss can help to find faults on the machine/system and rectify them. This is why Bosch Rexroth recommends always keeping the axial piston unit and system clean.	Daily
	Check axial piston unit for unusual noise development.	Daily
	Check mounting elements for tight seating. All fasteners have to be checked when the hydraulic system is switched off, depressurized and cooled down.	Monthly

10.3 Maintenance

The axial piston unit is low-maintenance when used as intended.

The service life of the axial piston unit is heavily dependent on the quality of the hydraulic fluid. This is why we recommend changing the hydraulic fluid at least once per year or every 2000 operating hours (whichever occurs first), or having it analyzed by the hydraulic fluid manufacturer or a laboratory to determine its suitability for further use.

The service life of the axial piston unit is limited to the service life of the bearings used if the permissible operating parameters are observed. You can ask your local contact person about service life based on load cycle. You can find their contact information at

<https://addresses.boschrexroth.com>

Based on these parameters, a maintenance interval should be determined by the system manufacturer for the replacement of the bearings and included in the maintenance schedule of the hydraulic system.

10.4 Repair

Bosch Rexroth offers a comprehensive range of services for the repair of Rexroth axial piston units.

Repairs on the axial piston unit and its assembled parts should only be performed by service centers certified by Bosch Rexroth.

- ▶ Only use original spare parts from Rexroth to repair the Rexroth axial piston units, otherwise the functional reliability of the axial piston unit cannot be guaranteed, and the warranty will be voided.

For questions regarding repairs, contact your proper Bosch Rexroth service partner or the service department of the manufacturer's plant of the axial piston unit; see chapter 10.5 "Spare parts" on page 49.

10.5 Spare parts

CAUTION

Use of unsuitable spare parts!

Spare parts that do not meet the technical requirements specified by Bosch Rexroth can cause injury and property damage!

- ▶ Only use original spare parts from Rexroth to repair the Rexroth axial piston units, otherwise the functional reliability of the axial piston unit cannot be guaranteed, and the warranty will be voided.

The spare parts lists for axial piston units are order-specific. When ordering spare parts, specify the material and serial number of the axial piston unit as well as the material numbers of the spare parts.

Address all questions regarding spare parts to your proper Bosch Rexroth Service partner or the service department of the manufacturer's plant of the axial piston unit.

Bosch Rexroth AG
An den Kelterwiesen 14
72160 Horb a.N., Germany
Hotline +49 9352 405060

Spare parts can be found online at www.boschrexroth.com/spc

For general inquiries, please contact your local contact person. You can find their contact information at

<https://addresses.boschrexroth.com>

11 Removal and replacement

11.1 Required tools

Removal can be performed using standard tools. No special tools are necessary.

11.2 Preparing for removal

1. Decommission the relevant system part as described in the instruction manual for the machine or system.
 - Relieve pressure in the hydraulic system according to the instructions of the machine or system manufacturer.
 - Make sure the relevant machine/system components are depressurized and de-energized.
2. Secure the relevant system part against reactivation.

11.3 Performing the removal

Proceed as follows to remove the axial piston unit:

1. Make sure you have the appropriate tools and wear personal protective equipment.
2. Allow the axial piston unit to cool down until it can be removed without danger.
3. For below-reservoir installation, before removing the axial piston unit, seal the connection to the reservoir and/or drain the reservoir.
4. Place a drip tray under the axial piston unit to collect any hydraulic fluid that may leak.
5. Disconnect the lines and collect the escaping hydraulic fluid in the drip tray.
6. Remove the axial piston unit. Use a suitable lifting device.
7. Completely drain the axial piston unit.
8. Plug all openings.

11.4 Preparing the components for storage or further use

- ▶ Proceed as described in chapter 6.2 "Storing the axial piston unit" on page 24.

12 Disposal

Careless disposal of the axial piston unit, the hydraulic fluid and the packaging material can result in environmental pollution.

Observe the following when disposing of the axial piston unit:

- 1.** Completely drain the axial piston unit.
- 2.** Dispose of the axial piston unit and packaging material in accordance with the regulations in your country.
- 3.** Dispose of the hydraulic fluid in accordance with the regulations of your country. Also observe the applicable safety data sheet for the hydraulic fluid.
- 4.** Disassemble the axial piston unit into its constituent parts for proper recycling.
- 5.** For example, separate the parts into:
 - Castings
 - Steel
 - Aluminum
 - Non-ferrous metal
 - Electronic waste
 - Plastic
 - Seals

13 Extension and conversion

Do not modify the axial piston unit and/or its assembled parts. Changes to settings on the customer side should only be made using the product-specific setting instructions.



The warranty from Bosch Rexroth only applies to the configuration as delivered. The warranty will be voided if the unit is modified or extended.



Adjusting the setting screws will render the warranty void. If you need to change the settings, please contact your local contact person; you can find their contact information at

<https://addresses.boschrexroth.com>

14 Troubleshooting

The Table 11 is intended to support troubleshooting. This table is not exhaustive. Issues may occur in practice that are not listed here.

Only authorized personnel may perform troubleshooting inside a safety area designated by the machine manufacturer.

14.1 How to proceed for troubleshooting

- ▶ Perform troubleshooting if possible with reduced operating data (e.g. slowly swinging in or out and slow pressure increase).
- ▶ Work systematically and in a targeted manner, even when pressed for time. Random, indiscriminate removal and changing of settings could make it impossible to determine the original cause of the fault.
- ▶ First get a general idea of how your product functions in conjunction with the entire system.
- ▶ Try to find out whether or not the product was working properly in conjunction with the entire system before the fault occurred.
- ▶ Try to determine any changes to the entire system in which the product is installed:
 - Have there been any changes to the application conditions or operating range of the product?
 - Has maintenance work recently been carried out? Is there an inspection or maintenance log?
 - Have any changes (e.g. upgrades) or repairs been made to the overall system (machine/system, electrics, control) or to the product? If yes: What changes?
 - Has the hydraulic fluid been changed?
 - Has the product or machine been used as intended?
 - How does the malfunction appear?
- ▶ Try to get a clear idea of the cause of the fault. Directly ask the (machine) operator.
- ▶ Document the work carried out.
- ▶ If the fault cannot be corrected, please refer to one of the contract addresses at: <https://addresses.boschrexroth.com>.

14.2 Malfunction table

Table 11: Axial piston unit malfunction table

Malfunction	Possible cause	Remedy
Unusual noises	Insufficient air bleeding of the hydraulic system	Fill the axial piston unit, suction line for the hydraulic pump and the reservoir
		Completely air bleed the axial piston unit and hydraulic system
		Check correct installation position
	Insufficient suction conditions, e.g., insufficient dimensioning of the suction line, viscosity of the hydraulic fluid too high, suction height too high, suction pressure too low, foreign particles in the suction line, impermissible filter in the suction line	Machine/system manufacturer: Check the system, e.g. optimize inlet conditions, use suitable hydraulic fluid
		Fill the suction line with hydraulic fluid
		Remove foreign particles from the suction line
	Drive speed too high	Machine/system manufacturer: Reduce drive speed
	Wrong direction of rotation	Machine/system manufacturer: Check correct direction of rotation, see chapter 7.4.1 "Preparation" on page 30
	Improper mounting of the axial piston unit	Check the mounting of the axial piston unit according to the specifications of the machine/system manufacturer – observe tightening torques
	Improper mounting of assembled parts, hydraulic lines or improper installation of the coupling	Fasten assembled parts according to the parameters provided by the coupling fitting manufacturer
Resonances due to a defective or unsuitable elastic coupling	Check the specification of the elastic coupling and/or exchange defective or worn coupling	
Valves and controller vibrate	Optimize the adjustment of the controller of the axial piston unit and the pressure limitation in the hydraulic system	
Increased, unusual vibration	Mechanical damage to the axial piston unit (e.g. bearing damage)	Replace axial piston unit
		Contact Bosch Rexroth Service
Increased, unusual vibration	Bearings worn	Contact Bosch Rexroth Service

Table 11: Axial piston unit malfunction table

Malfunction	Possible cause	Remedy	
No or insufficient flow	Insufficient air bleeding of the hydraulic system	Fill the axial piston unit, suction line for the hydraulic pump and the reservoir Completely air bleed the axial piston unit and hydraulic system	
	Faulty mechanical drive (e.g. defective coupling)	Contact machine/system manufacturer	
	Drive speed too low	Contact machine/system manufacturer	
	Insufficient suction conditions, e.g., insufficient dimensioning of the suction line, viscosity of the hydraulic fluid too high, suction height too high, suction pressure too low, foreign particles in the suction line, impermissible filter in the suction line		Machine/system manufacturer: Check the system, e.g. optimize inlet conditions, use suitable hydraulic fluid
			Fill the suction line with hydraulic fluid
			Remove foreign particles from the suction line
	Hydraulic fluid not in optimal viscosity range	Machine/system manufacturer: Check temperature range and use suitable hydraulic fluid	
	Insufficient pilot pressure or control pressure		Check pilot pressure or control pressure
			Contact Bosch Rexroth Service
	Malfunction of the control device or controller of the axial piston unit	Contact Bosch Rexroth Service	
	Control of the control device defective	Check control (contact machine/system manufacturer or Bosch Rexroth Service)	
	Wear or mechanical damage to the axial piston unit		Replace axial piston unit
		Contact Bosch Rexroth Service	

Table 11: Axial piston unit malfunction table

Malfunction	Possible cause	Remedy
No or insufficient pressure	Insufficient air bleeding of the hydraulic system	Fill the axial piston unit, suction line for the hydraulic pump and the reservoir
		Completely air bleed the axial piston unit and hydraulic system
		Check correct installation position
	Faulty mechanical drive (e.g. defective coupling)	Contact machine/system manufacturer
	Drive power too low	Contact machine/system manufacturer
	Insufficient suction conditions, e.g., insufficient dimensioning of the suction line, viscosity of the hydraulic fluid too high, suction height too high, suction pressure too low, foreign particles in the suction line, impermissible filter in the suction line	Machine/system manufacturer: Check the system, e.g. optimize inlet conditions, use suitable hydraulic fluid
		Fill the suction line with hydraulic fluid
		Remove foreign particles from the suction line
	Hydraulic fluid not in optimal viscosity range	Machine/system manufacturer: Check temperature range and use suitable hydraulic fluid
	Insufficient pilot pressure or control pressure	Check pilot pressure or control pressure
Contact Bosch Rexroth Service		
Malfunction of the control device or controller of the axial piston unit	Contact Bosch Rexroth Service	
Control of the control device defective	Check control (contact machine/system manufacturer or Bosch Rexroth Service)	
Wear or mechanical damage to the axial piston unit	Replace axial piston unit	
	Contact Bosch Rexroth Service	
Output unit defective (e.g. hydraulic motor or cylinder)	Contact machine/system manufacturer	
Pressure/flow fluctuations/ instabilities	Insufficient air bleeding of the hydraulic system	Fill the axial piston unit, suction line for the hydraulic pump and the reservoir
		Completely air bleed the axial piston unit and hydraulic system
		Check correct installation position
	Insufficient suction conditions, e.g., insufficient dimensioning of the suction line, viscosity of the hydraulic fluid too high, suction height too high, suction pressure too low, foreign particles in the suction line, impermissible filter in the suction line	Machine/system manufacturer: Check the system, e.g. optimize inlet conditions, use suitable hydraulic fluid
		Fill the suction line with hydraulic fluid
		Remove foreign particles from the suction line
	Valves and controller vibrate	Optimize the adjustment of the controller of the axial piston unit and the pressure limitation in the hydraulic system
	Unstable control signal	Contact machine/system manufacturer or Bosch Rexroth Service
Malfunction in the control devices or the controller	Contact Bosch Rexroth Service	

Table 11: Axial piston unit malfunction table

Malfunction	Possible cause	Remedy
Excessively high temperature of hydraulic fluid and housing	Excessively high inlet temperature at the axial piston unit	Machine/system manufacturer: Inspect system, e.g. malfunction in the cooler, insufficient hydraulic fluid in the reservoir
	Wrong setting and/or malfunction of the pressure control valves (e.g. pressure controller)	Optimize the adjustment of the pressure control valves of the axial piston unit and the pressure limitation in the hydraulic system
		Contact Bosch Rexroth Service
		Contact machine/system manufacturer
	Axial piston unit worn	Replace axial piston unit; contact Bosch Rexroth Service

15 Technical data

The permissible technical data for your axial piston unit can be found on the data sheet 92050.



The data sheet can be found in the Download Center:

www.boschrexroth.com/ics/ref/media/92050



Additional information can be found in the Rexroth store:

www.boschrexroth.com/p-A4VSO

Order-related technical data for your axial piston unit can be found in the order confirmation.

16 Alphabetical index

A

Abbreviations.....	8
Above-reservoir installation	30
Assembly	30

B

Below-reservoir installation	28
------------------------------------	----

C

Care	47
Circuit	
Open.....	19
Cleaning	47
Commissioning.....	42
initial	42
Connection	
electric.....	41
hydraulic	35
Control.....	20
Conversion	52
Corrosion protection	24
Corrosion protection film.....	24
Cradle	19
Cylinder.....	19

D

Designations.....	8
Dimensions.....	22, 32
Direction of rotation	31
Disposal	51
Distributor plate	19
Drive shaft.....	19

E

Eye bolt	23
----------------	----

F

Filling	42
Flushing cycle.....	41
Functional description	
Control.....	20
Motor function	20
Functional test.....	44

H

High-pressure side.....	19
-------------------------	----

I

Identification	21
Inside-reservoir installation	29
Inspection	48
Installation	26
Completion	34
General instructions.....	32
On a gearbox.....	33
on gearbox	33
Preparation	30
With cardan shaft.....	33
With coupling.....	32
Installation conditions	26
Installation position	
Above-reservoir installation	30
Below-reservoir installation.....	28
Inside-reservoir installation.....	29
Intended use	9

L

Layout	19
Lifting devices	22
Lifting strap.....	23

M

Maintenance	47, 48
Malfunction table	54

N

Name plate	21
Notes	
General	32

O

Operation	46
-----------------	----

P

Performance description.....	19
Piston	19
Port overview	38
Port plate	19
Product description	19
Property damage	15
Pump.....	20

Q

Qualification	10
---------------------	----

R

Recommissioning	
After standstill	45
Removal.....	50
Performing	50
Preparing	50
Repair.....	49
Replacement.....	50
Required documentation	5
Retaining plate	19
Running-in phase.....	45

S

Safety instructions.....	9
General	11
Product-specific	12
Signal word.....	7
Scope of delivery	18
Slipper pad.....	19
Spare parts.....	49
Storage.....	22, 24
Storage time.....	24
Stroking piston	19
Suction port	19
Suction side	19
Swivel angle indicator.....	31
Symbols	7

T

Tightening torques.....	39
Tools.....	50
Transport.....	22
by hand.....	22
with eye bolt	23
with lifting strap	23
Transporting	22
Transport protection.....	34
Troubleshooting.....	53

U

Unpacking.....	26
----------------	----

W

Warranty.....	17, 52
Weight.....	22

Bosch Rexroth AG

An den Kelterwiesen 14
72160 Horb a.N.
Germany
Phone +49 7451 92-0
sales.industry.horb@boschrexroth.de
sales.mobile.horb@boschrexroth.de
www.boschrexroth.com

Your local contact person can be found at:

<https://addresses.boschrexroth.com>